

# FTP-V, FTU-V, FTW-V

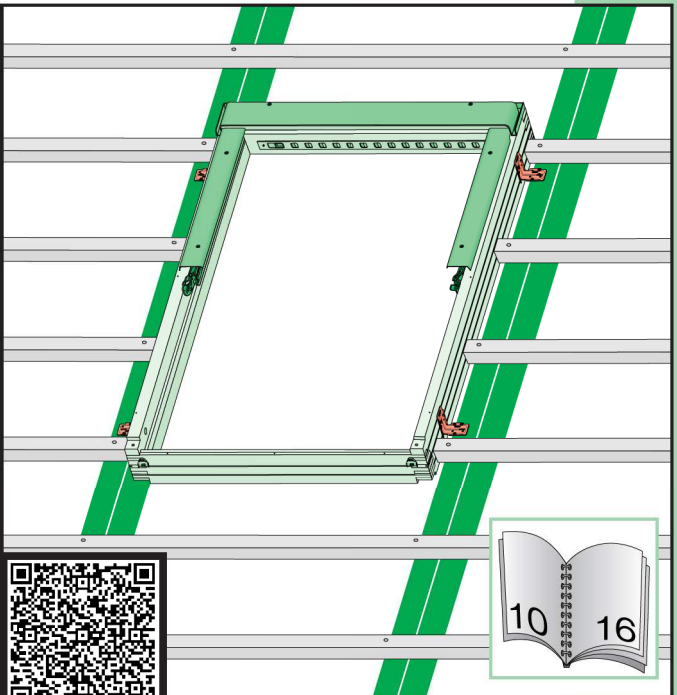

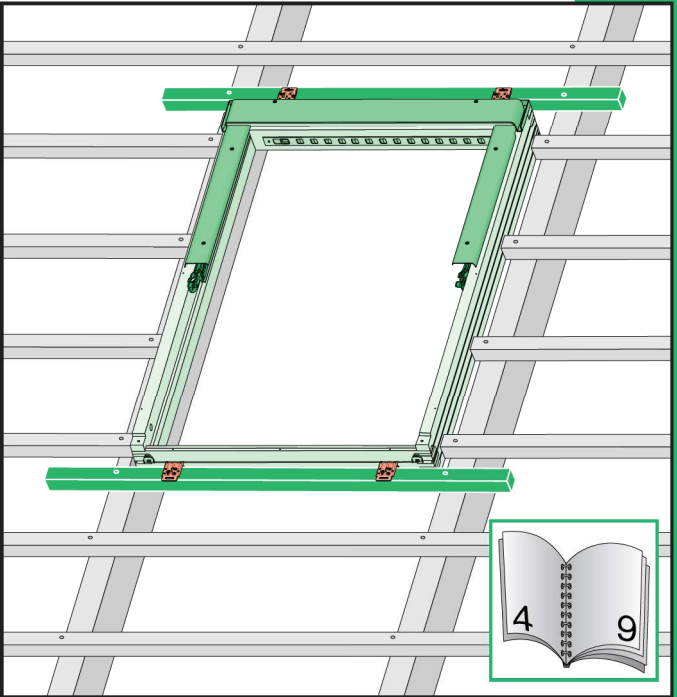

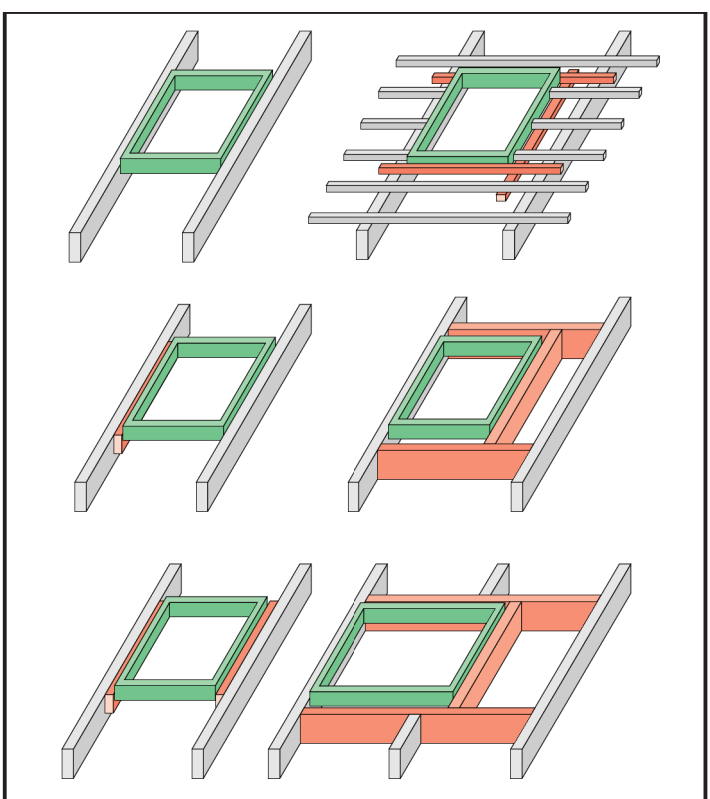

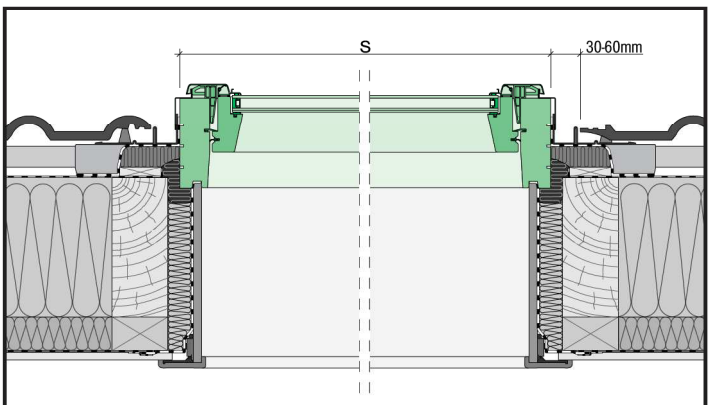
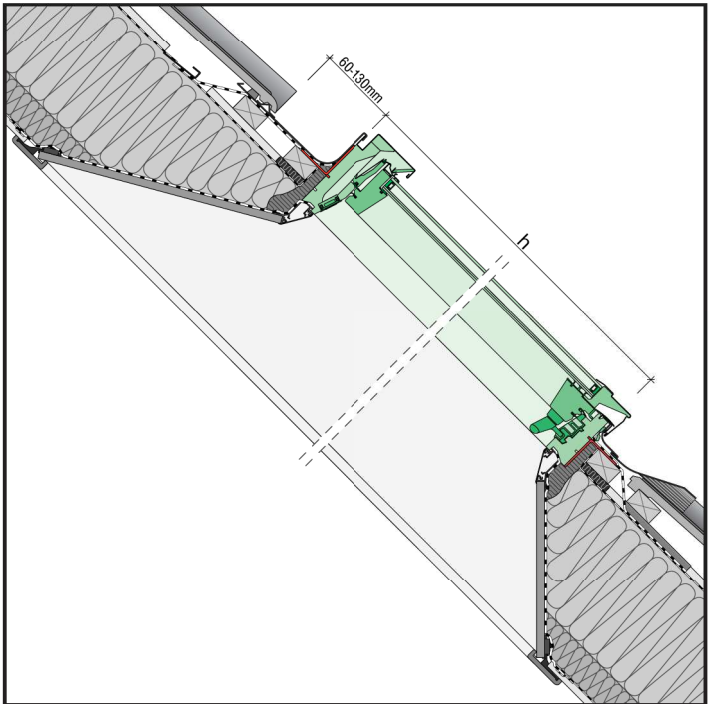
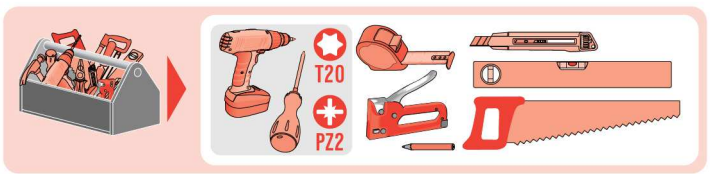
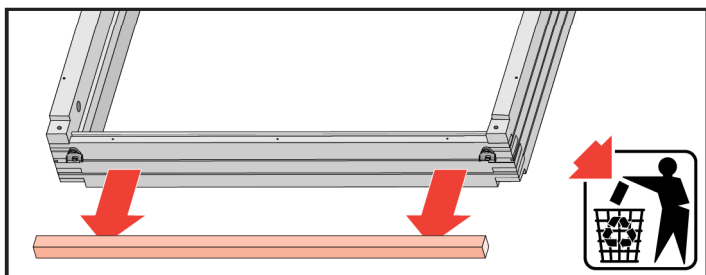
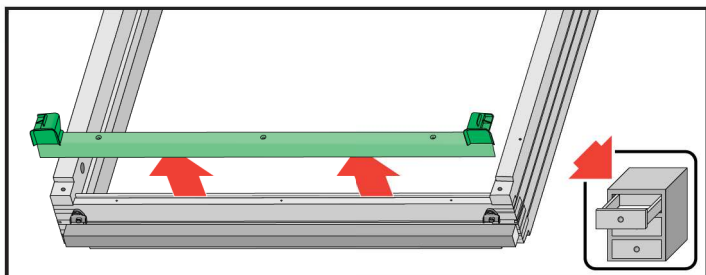
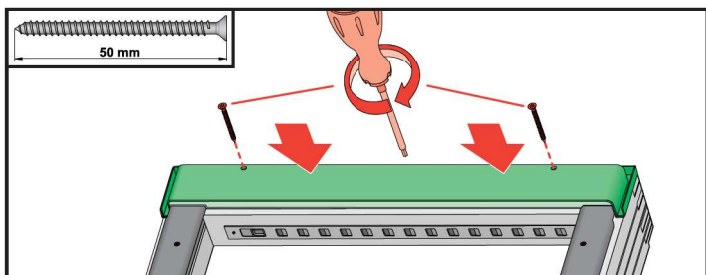
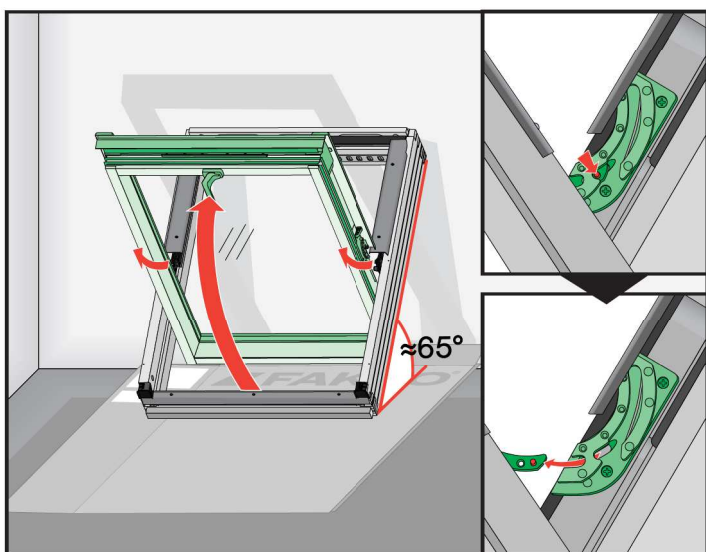
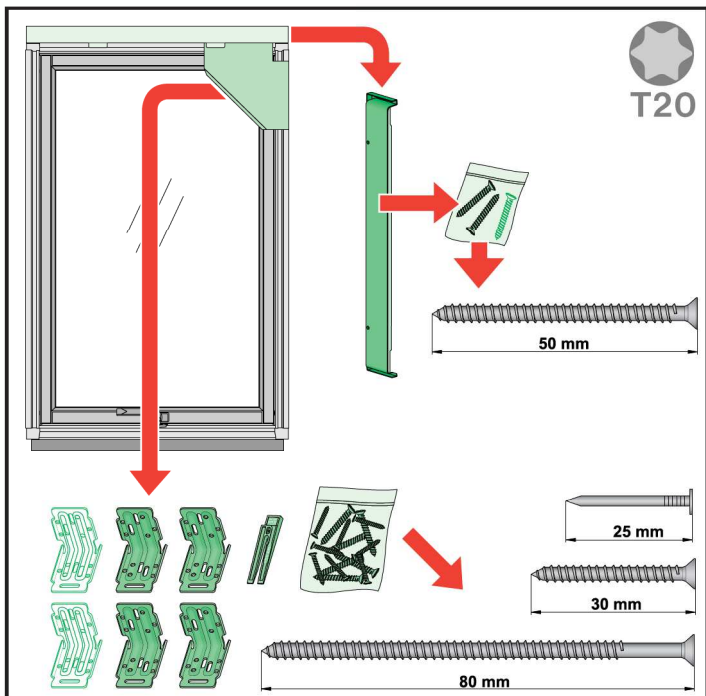
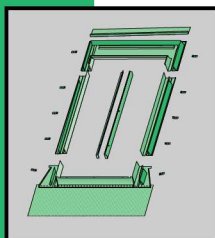
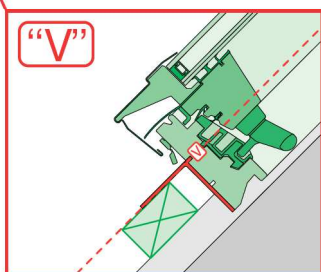
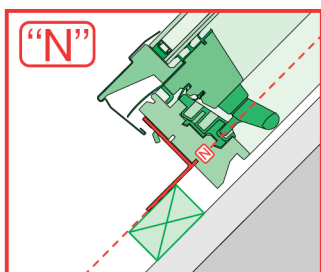
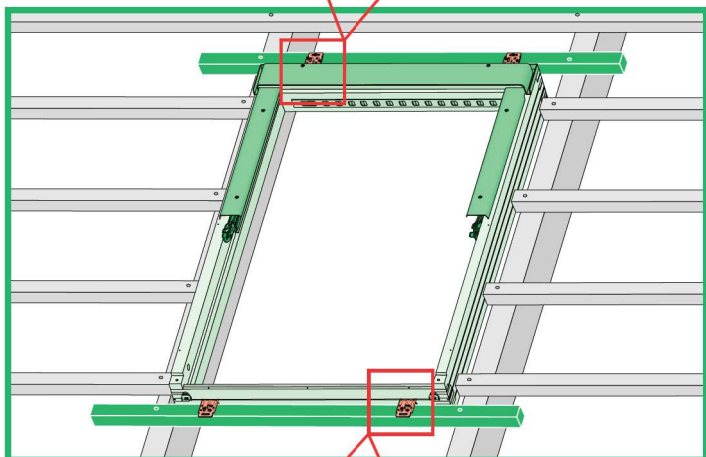
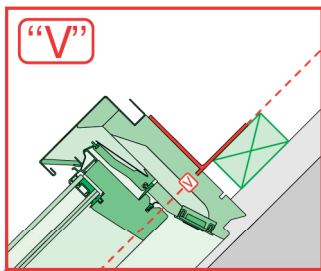
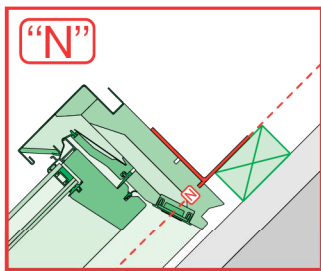

max 90mm



EHN

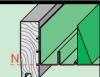

EHV

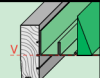

-

-

-

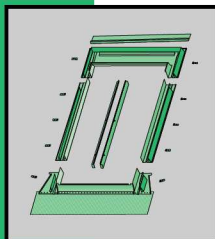

max 45mm

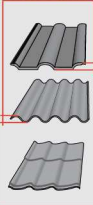

EZN

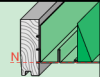

EZV

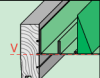

-

-

-

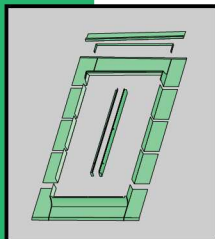

max 15mm (N)  
max 5mm (V)

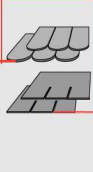

ELN

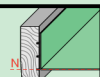

ELV

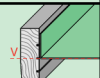

-

-

-

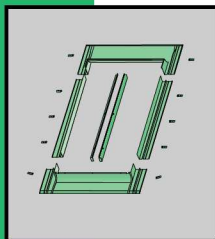

max 5mm

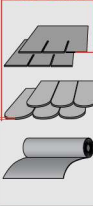

ESN

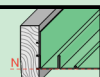

ESV

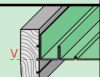

-

-





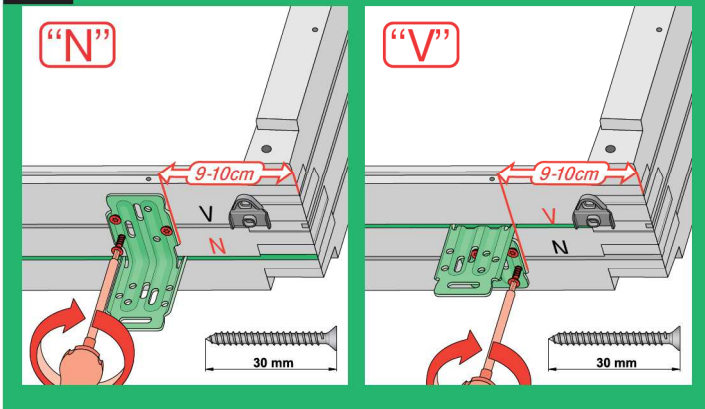



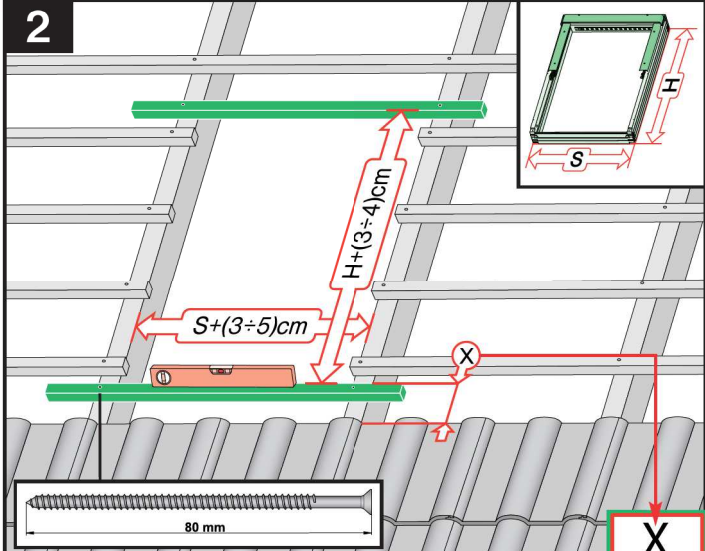

-

1

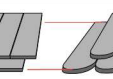
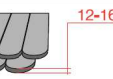
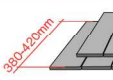
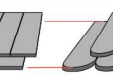
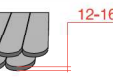

2

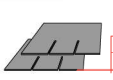
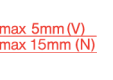
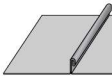

			max 90mm	EHN EHV	7-10cm 7-10cm
			max 45mm	EZN EZV	6-8cm 6-8cm
			12-16mm	EGV	6cm
			12-16mm	EPV	6cm
			max 5mm (V) max 15mm (N)	ELN ELV	0-2cm 0-2cm
				EEN EEV	0-2cm 0-2cm

3

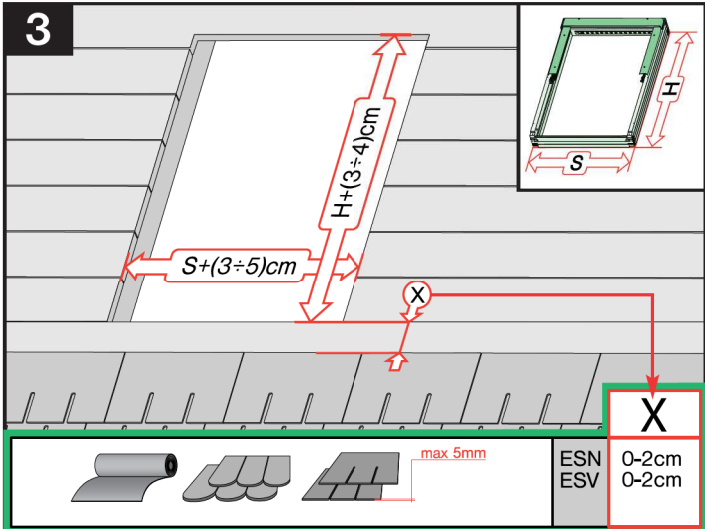

			max 5mm	ESN ESV	0-2cm 0-2cm
---	---	---	---------	------------	----------------

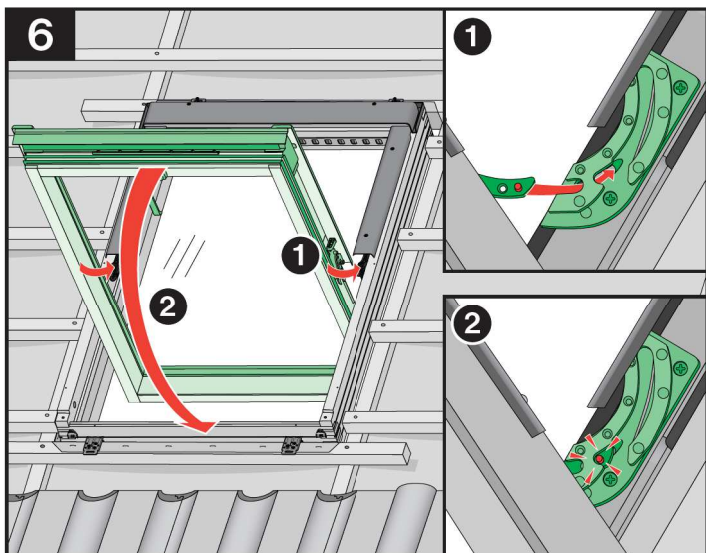
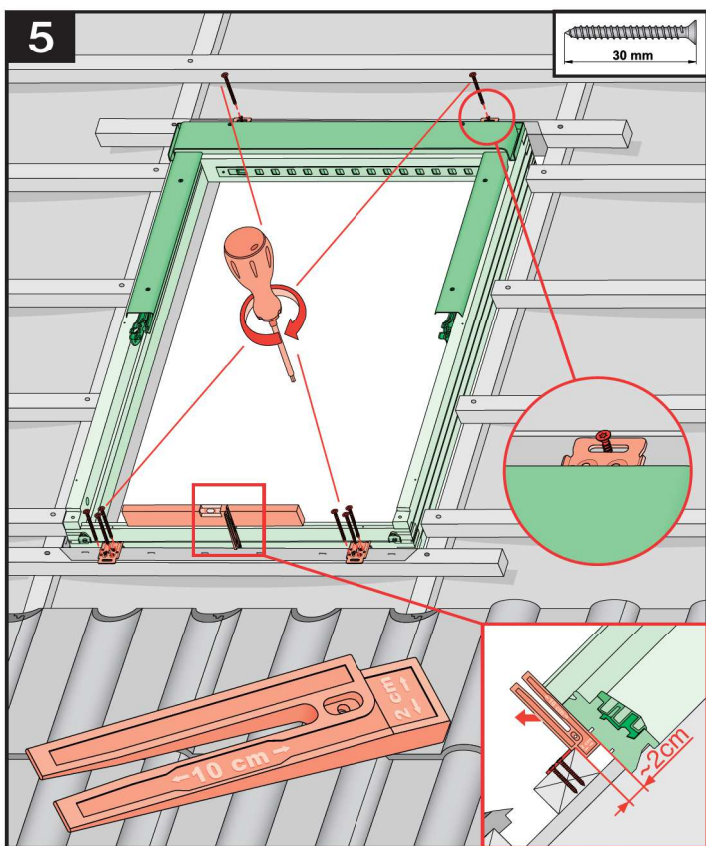
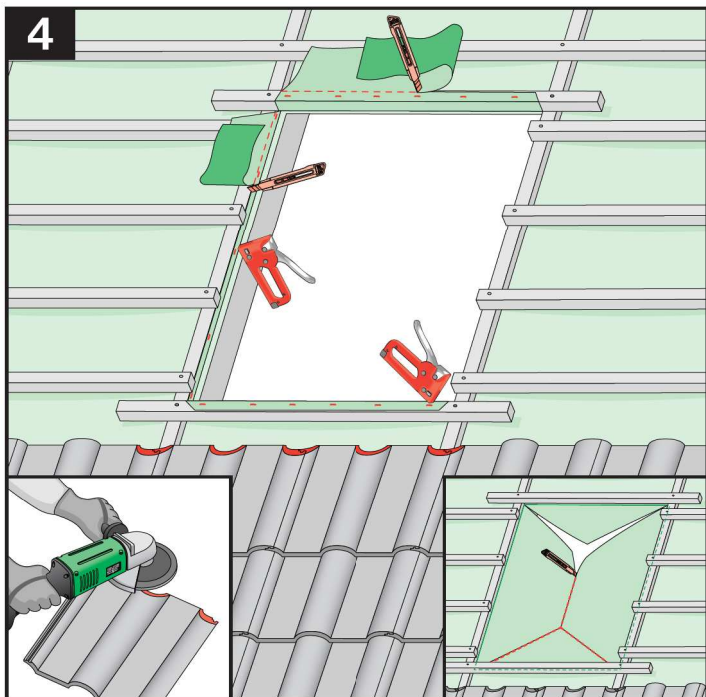

7

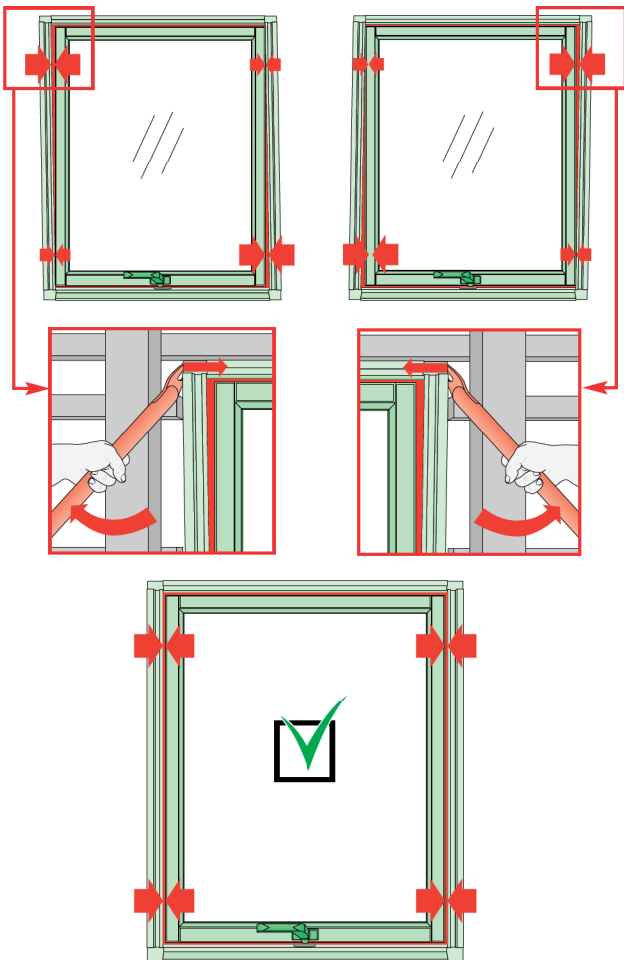

8

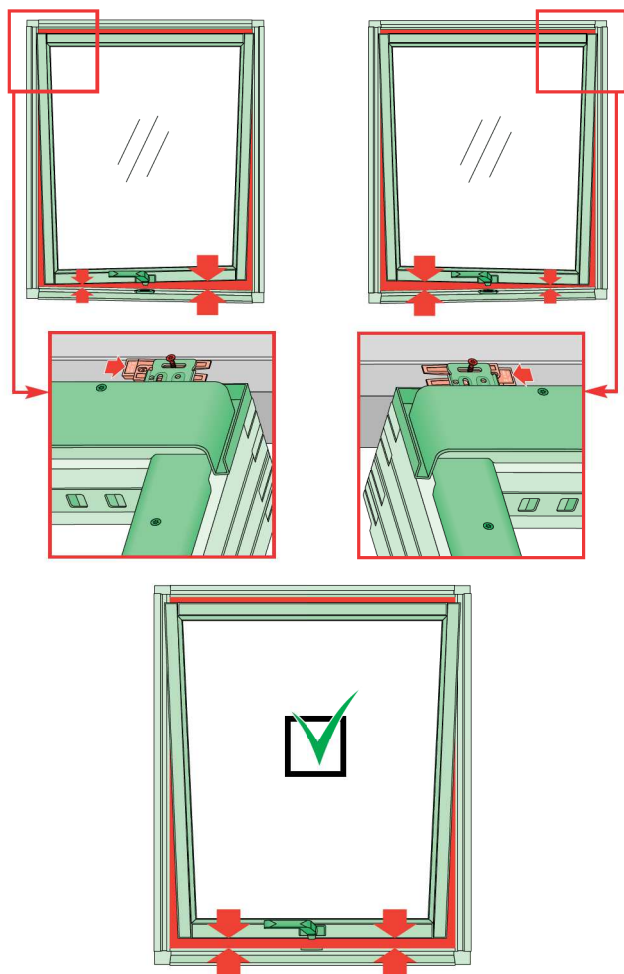

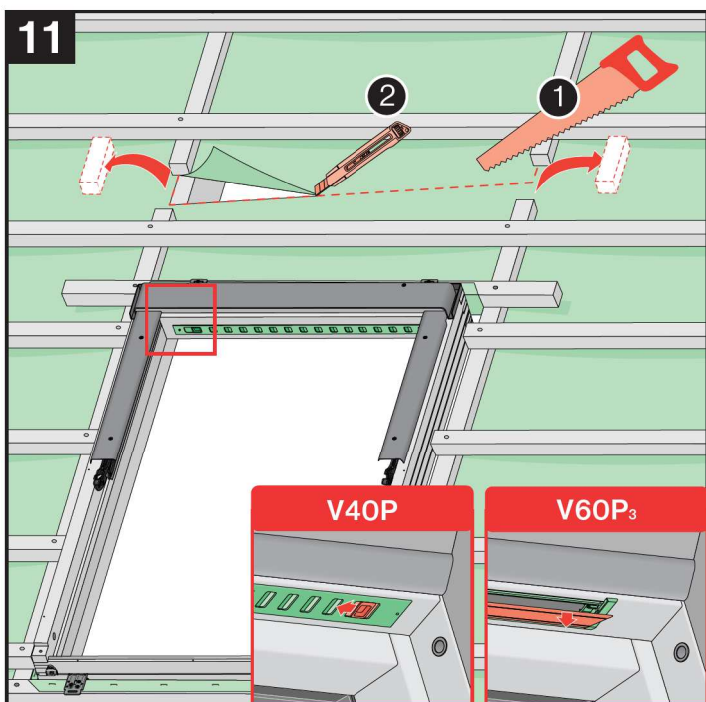
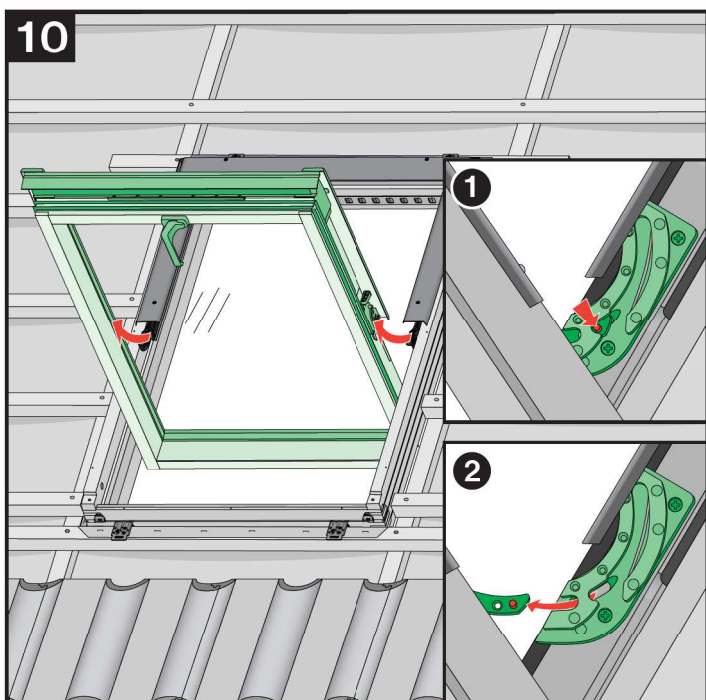
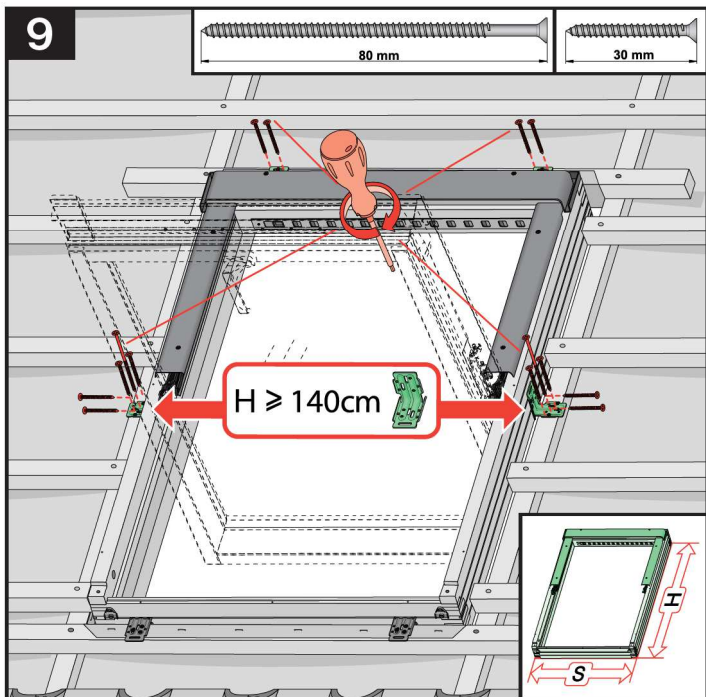





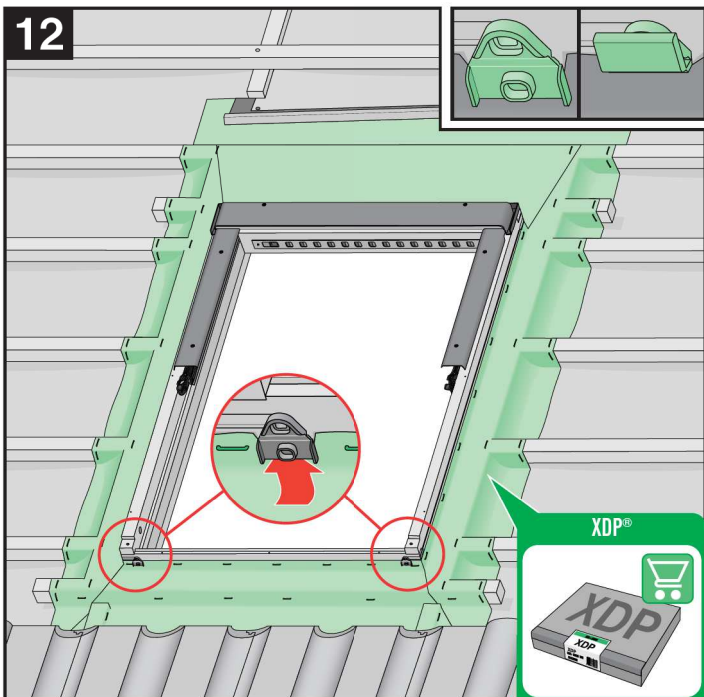



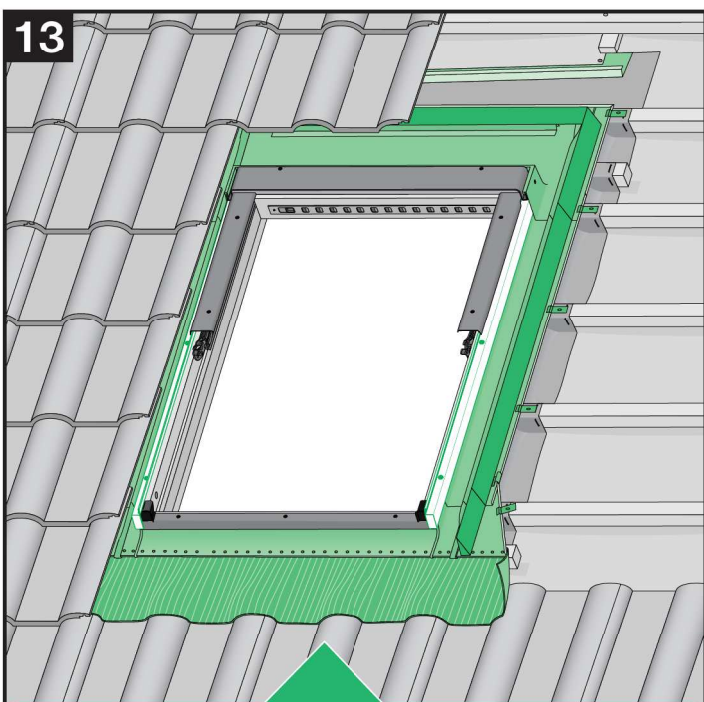

12

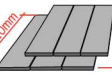

13

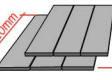
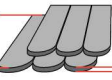
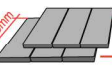

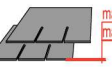
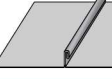
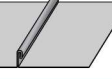
		max 90mm	EHN EHV
		max 45mm	EZN EZV
		max 5mm	ESN ESV
		12-16mm	EGV
		max 18mm	EPV
		max 5mm (V) max 15mm (N)	ELN ELV
			EEN EEV

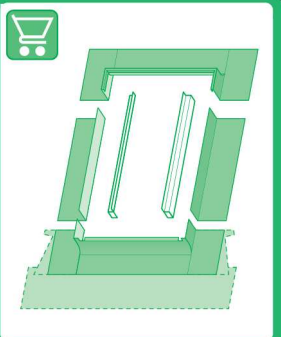

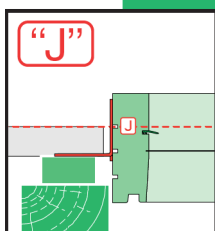
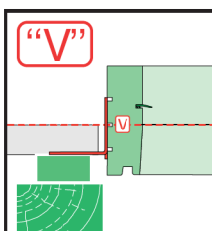
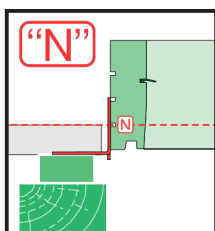
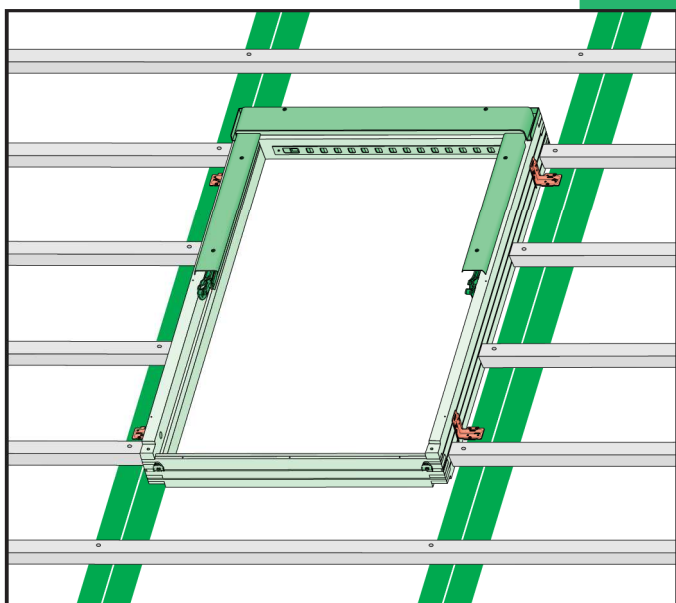

	<p>max 90mm</p>	EHN		
		EHV		
		-		-

	<p>max 45mm</p>	EZN		
		EZV		
		EZJ		

	<p>max 15mm (N) max 5mm (V) max 5mm (J)</p>	ELN		
		ELV		
		ELJ		

	<p>max 5mm</p>	ESN		
		ESV		
		ESJ		

1

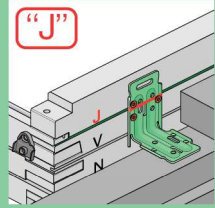
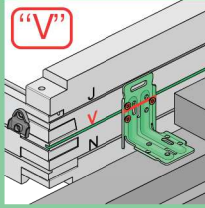
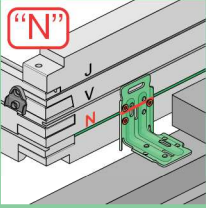
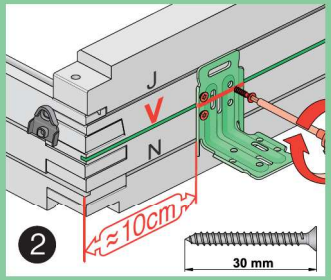
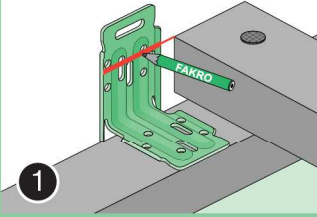

2

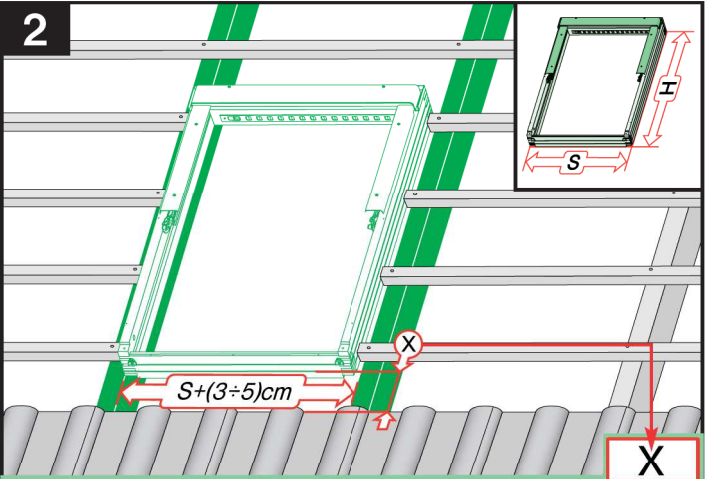

X

<p>max 90mm</p>	EHN EHV	9-12cm 9-12cm
<p>max 45mm</p>	EZN EZV EZJ	8-10cm 8-10cm 20cm
<p>12-16mm 380-420mm</p>	EGV	6cm
<p>max 18mm 250-280mm</p>	EPV	8cm
<p>max 5mm (V,J) max 15mm (N)</p>	ELN ELV ELJ	0-4cm 0-4cm 11cm
	EEN EEV EEJ	0-4cm 0-4cm 11cm

3

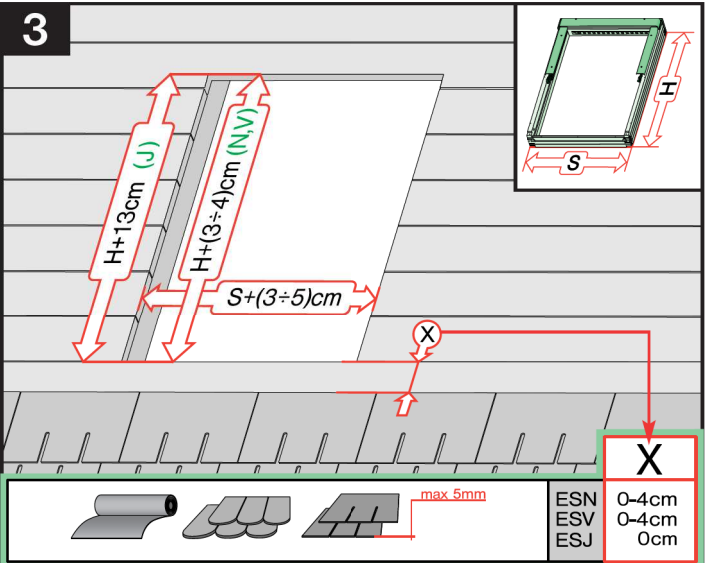

X

<p>max 5mm</p>	ESN ESV ESJ	0-4cm 0-4cm 0cm
----------------	-------------------	-----------------------

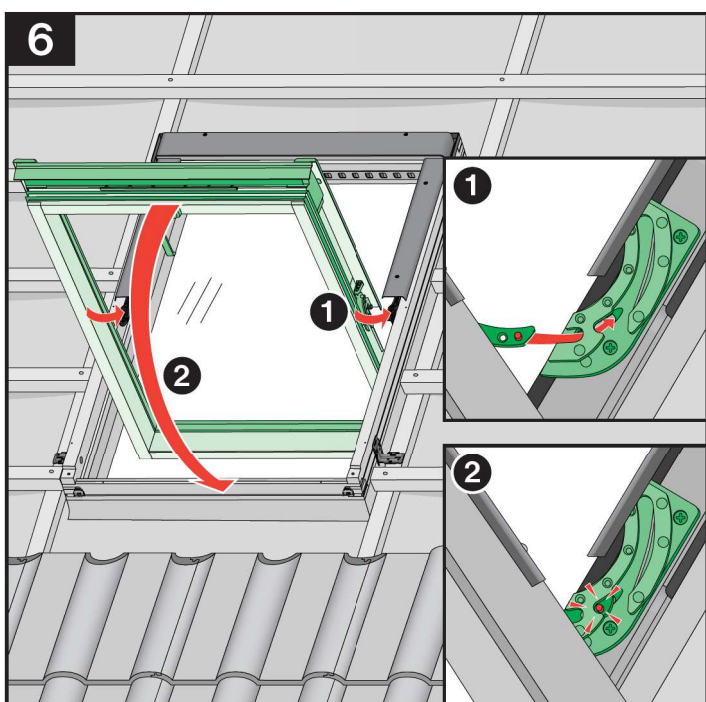
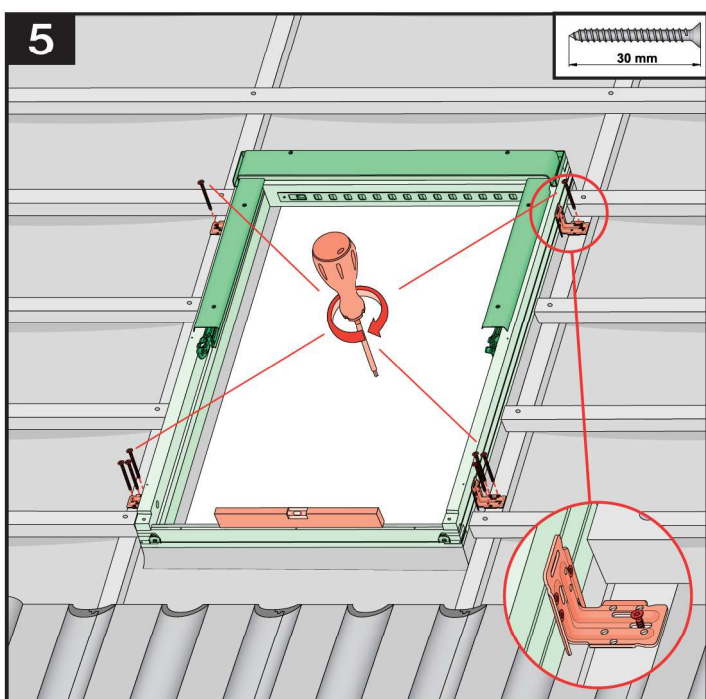
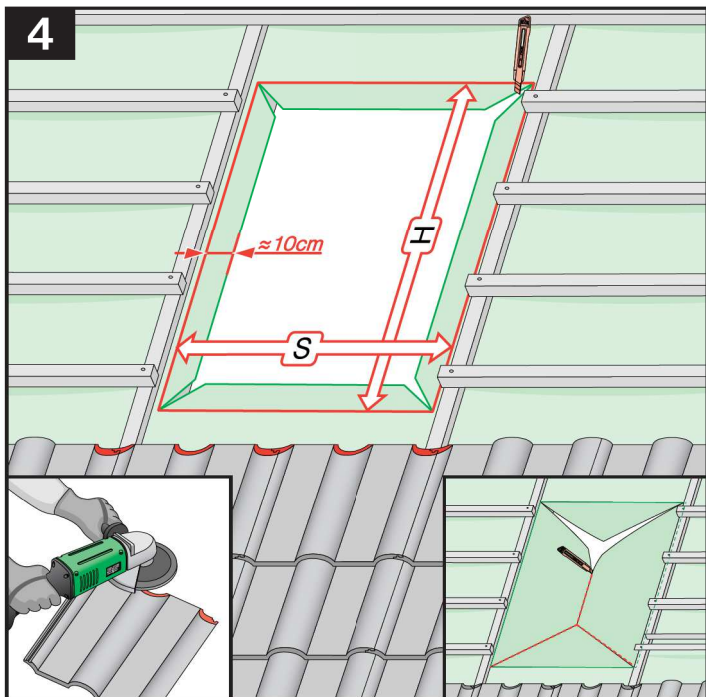

7

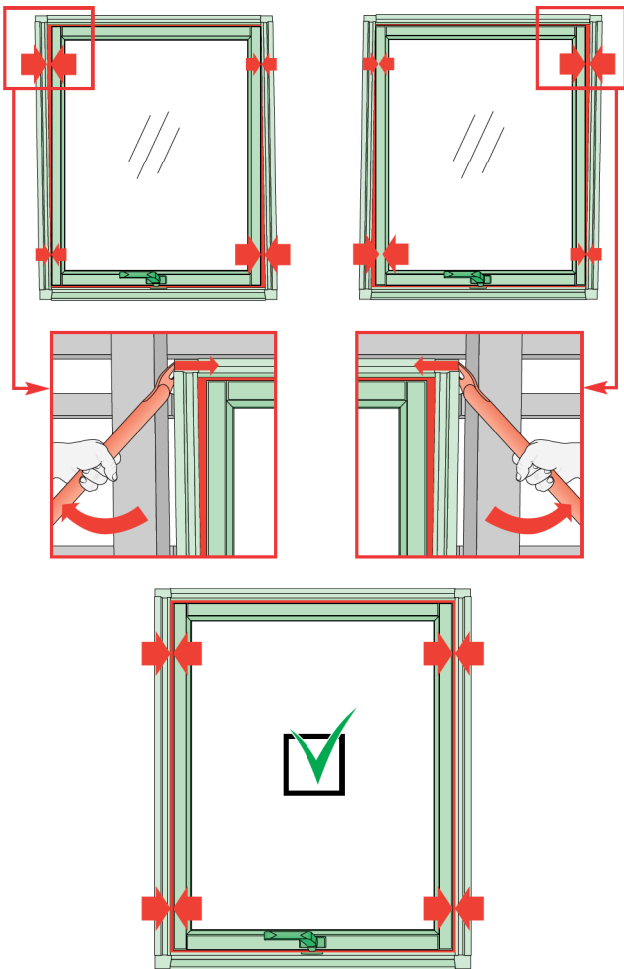

8

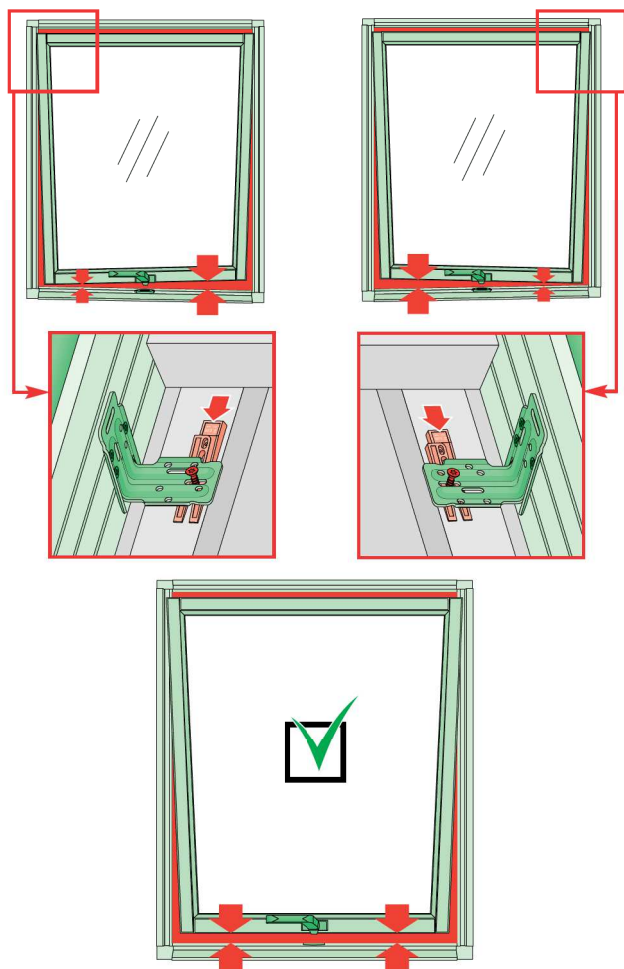

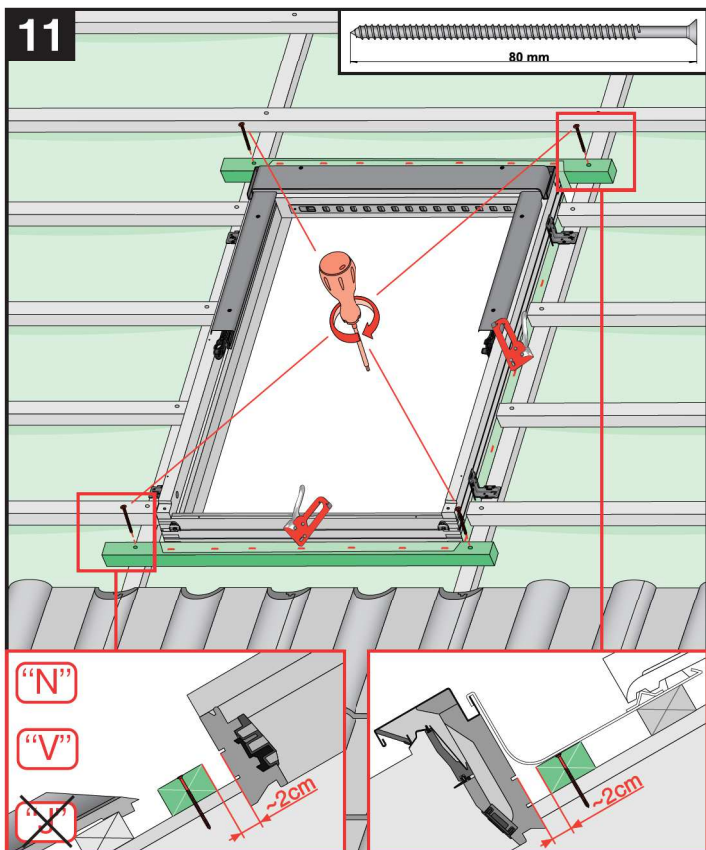
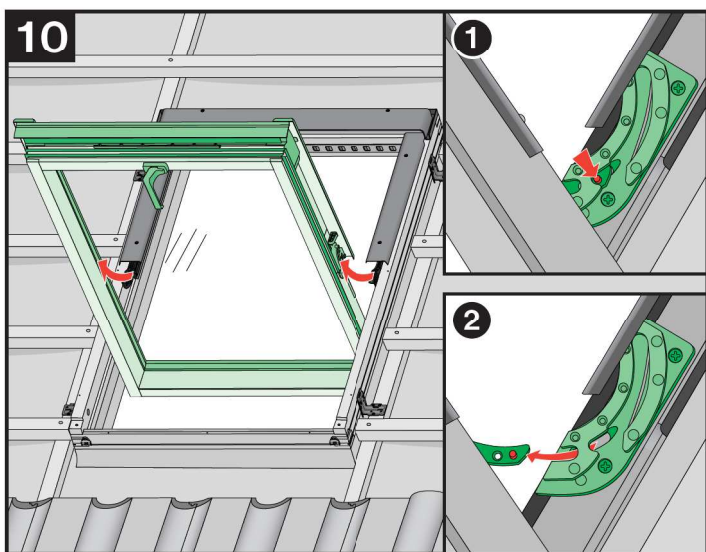
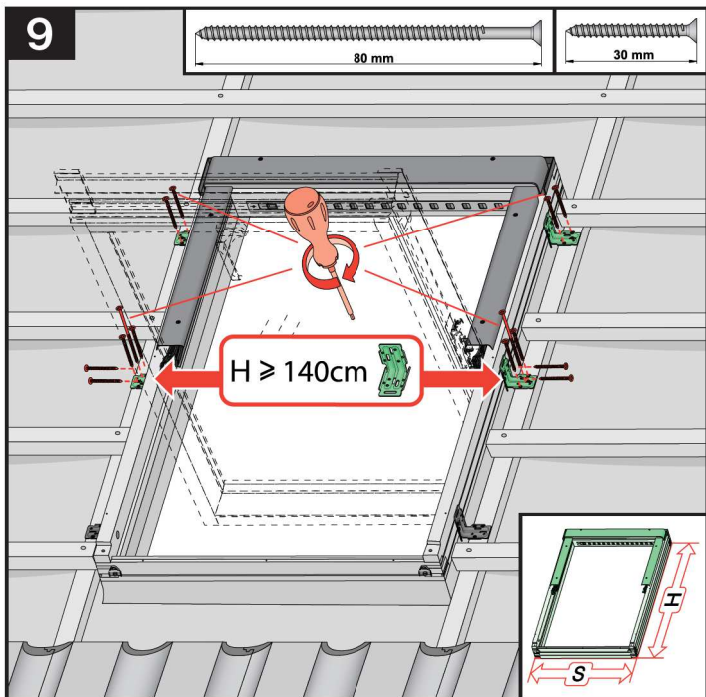

12

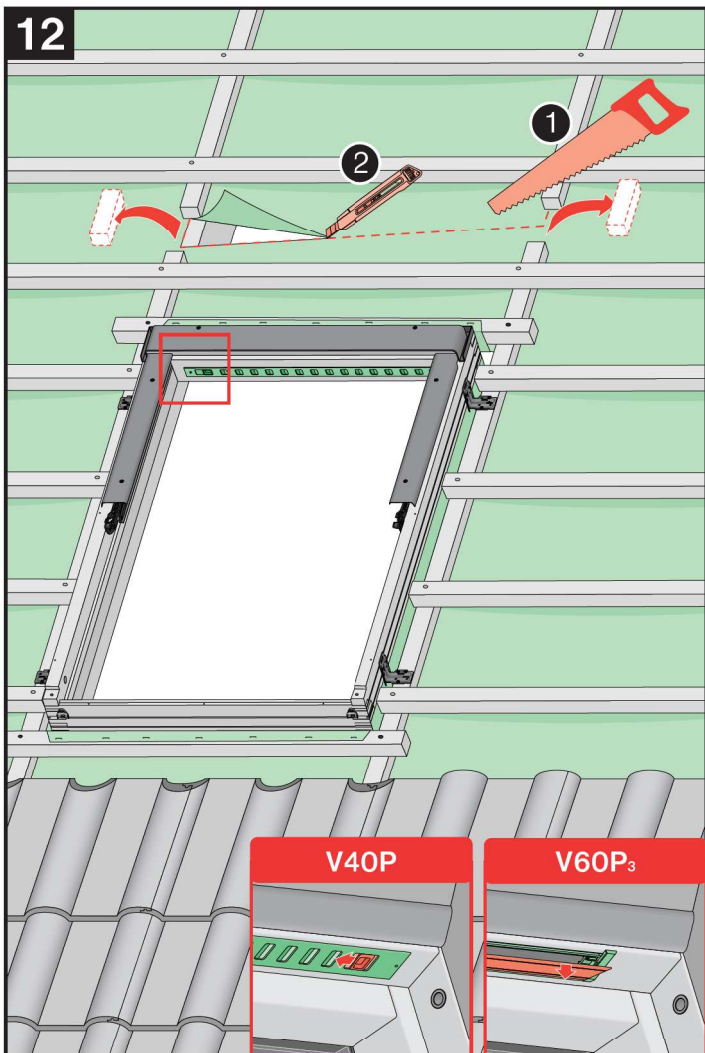

13

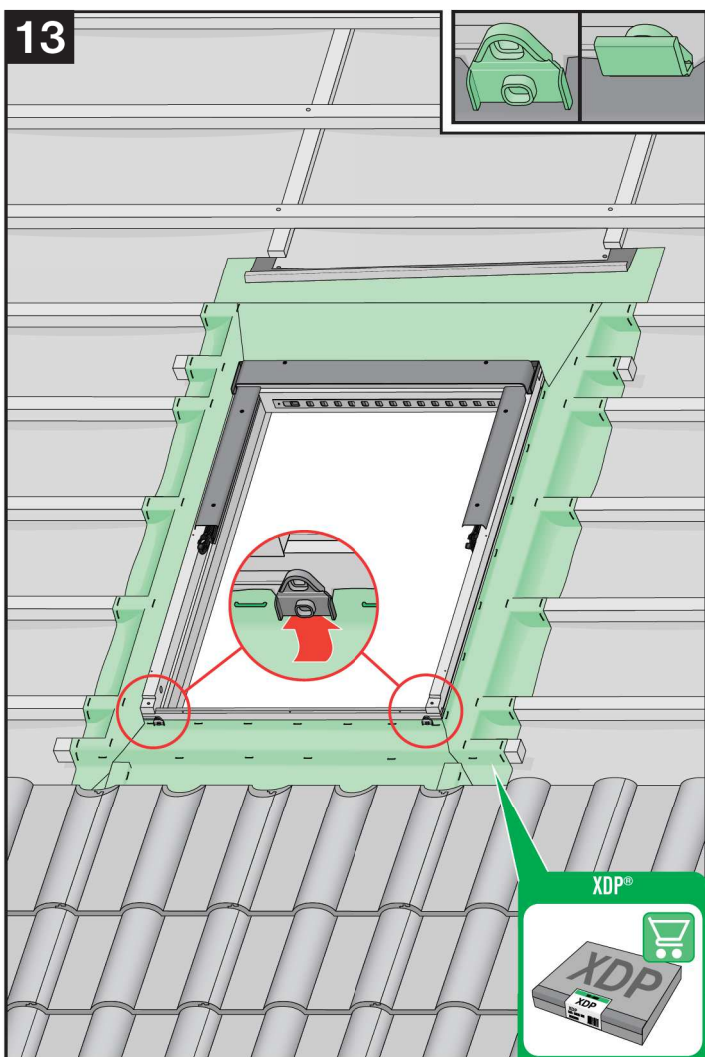

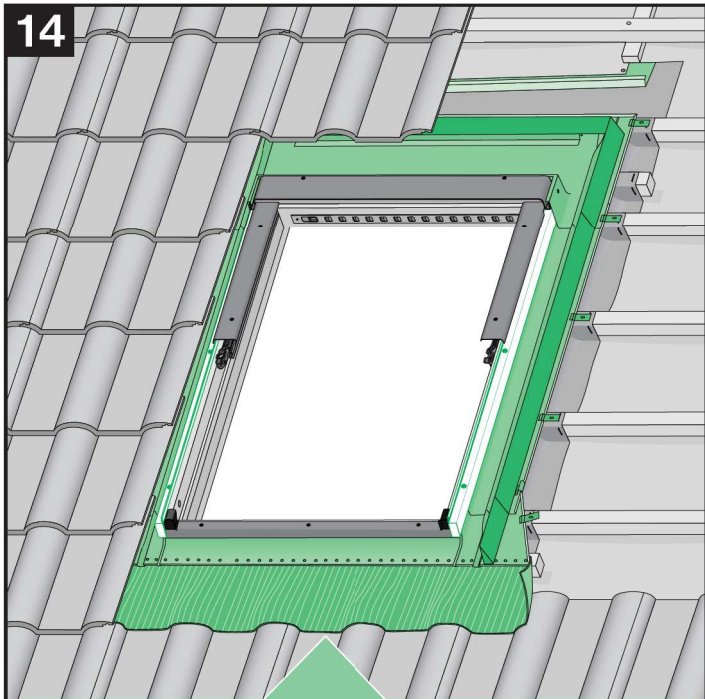
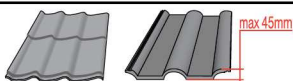
EHN  
EHVEZN  
EZV  
EZJESN  
ESV  
ESJ

EGV

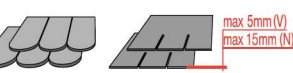
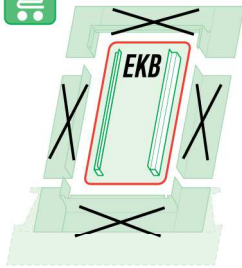
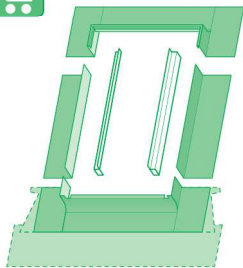

EPV

ELN  
ELV  
ELJEEN  
EEV  
EEJ

**CZ** Výrobce a prodejce nenesou žádnou odpovědnost za nedodržení příslušných ustanovení zákona, stavebních předpisů a bezpečnostních požadavků uživatelem výrobku, architektem, montérem nebo majitelem objektu.

**DE** Hersteller und Verkäufer übernehmen keine Haftung für Nichtbeachtung entsprechender Rechts- und Bauvorschriften sowie Sicherheitsanforderungen seitens Produktbenutzers, Architekten, Monteurs oder Gebäudebesitzers.

**ES** El fabricante y el vendedor no tienen ninguna responsabilidad por el incumplimiento de la ley vigente, normas de construcción y exigencias de seguridad por parte del usuario del producto, arquitecto, instalador o el propietario del edificio.

**FR** Le fabricant et le revendeur ne prend aucune responsabilité de ne pas respecter les lois applicables, les règlements sur les bâtiments et les exigences de sécurité par l'utilisateur du produit, l'architecte, l'installateur ou le propriétaire du bâtiment.

**GB** Manufacturer and Seller shall bear no liability for failure to comply with the applicable laws, building codes and safety requirements by the user of the product, architect, fitter or owner of the building.

**HU** A Gyártó és a Forgalmazó nem vállal semmiféle felelősséget a vonatkozó törvényi, építési és biztonsági előírások, termékelhasználók, építész, beépítőmester vagy épülettulajdonos általi nem tartásáért.

**IT** Il Produttore e il Rivenditore non potranno essere ritenuti responsabili per il mancato rispetto, da parte dell'utente del prodotto, del progettista, dell'installatore o del proprietario dell'edificio, delle leggi vigenti, nonché dei regolamenti edilizi e di quelli relativi alla sicurezza.

**NL** De fabrikant en verkoper zijn niet aansprakelijk voor gevolgen bij het niet opvolgen van voorschriften, wetten, bouwvoorschriften en veiligheidsvoorschriften door de gebruiker van het product, de architect, de installateur of de eigenaar van het gebouw.

**PL** Producent i Sprzedawca nie ponosi żadnej odpowiedzialności za nieprzestrzeganie stosownych przepisów prawa, przepisów budowlanych i wymogów bezpieczeństwa przez użytkownika produktu, architekta, montażystę lub właściciela budynku.

**PT** O fabricante e o vendedor não tem nenhuma responsabilidade pelo o não cumprimento da lei, códigos de construção e as exigências de segurança por parte do usuário do produto, arquiteto, instalador ou proprietário do edifício.

**RO** Nu producătorul, nici distribuitorul nu își vor asuma niciun fel de răspundere pentru nerespectarea legilor în vigoare, a legilor din domeniul construcțiilor sau a măsurilor de siguranță impuse utilizatorilor produsului, arhitecților, montajorilor sau proprietarilor clădirii.

**RU** В случае несоблюдения архитектором, монтажником или владельцем здания строительных правил и норм безопасности ответственность с производителя и продавца снимается.

**SK** Výrobca a predajca nenesú žiadnu zodpovednosť za nedodržanie príslušných ustanovení zákona, stavebných predpisov a bezpečnostných požiadaviek užívateľom výrobku, architektom, montérom alebo majiteľom objektu.