

Montážní návod ESTIMA

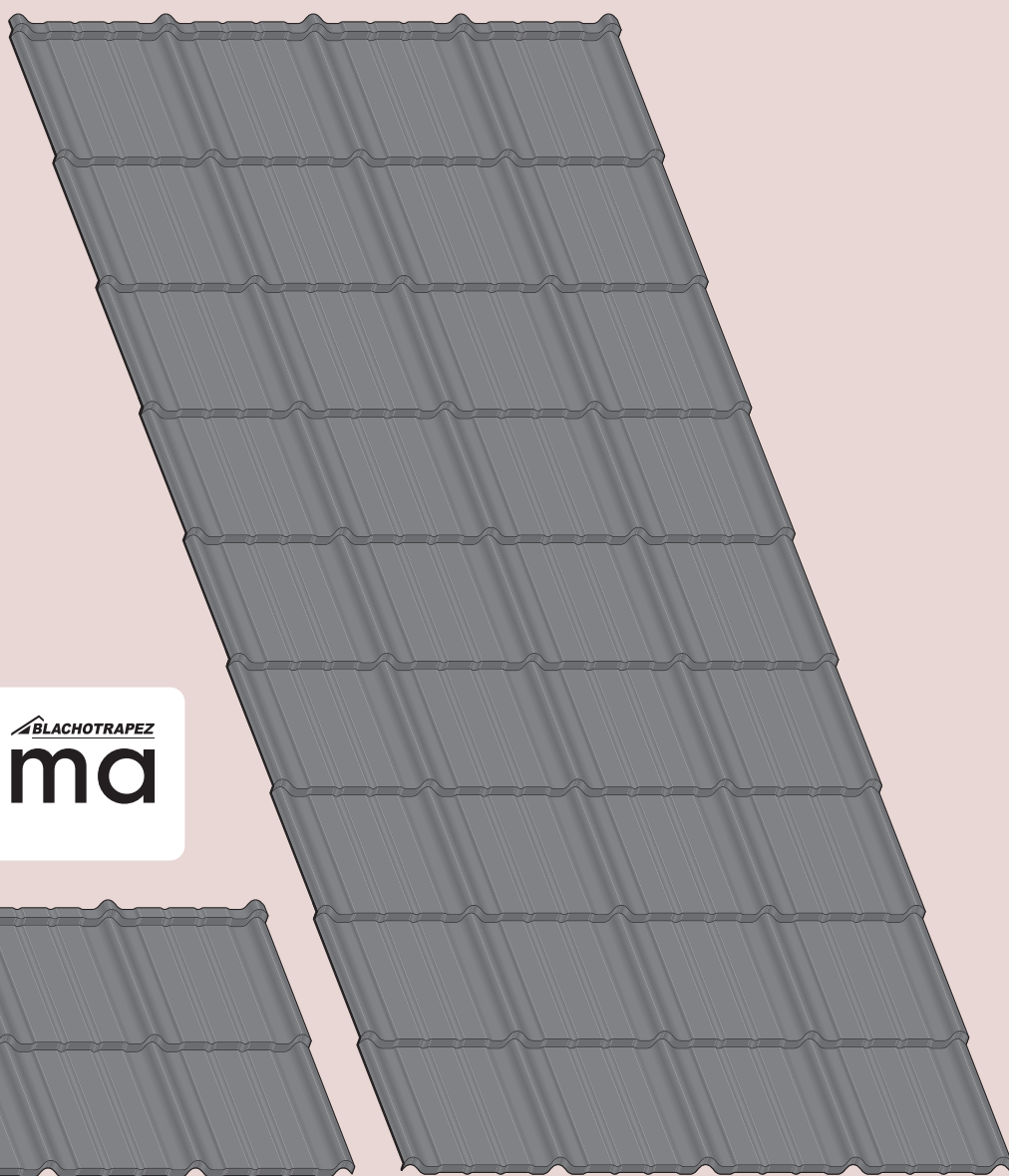

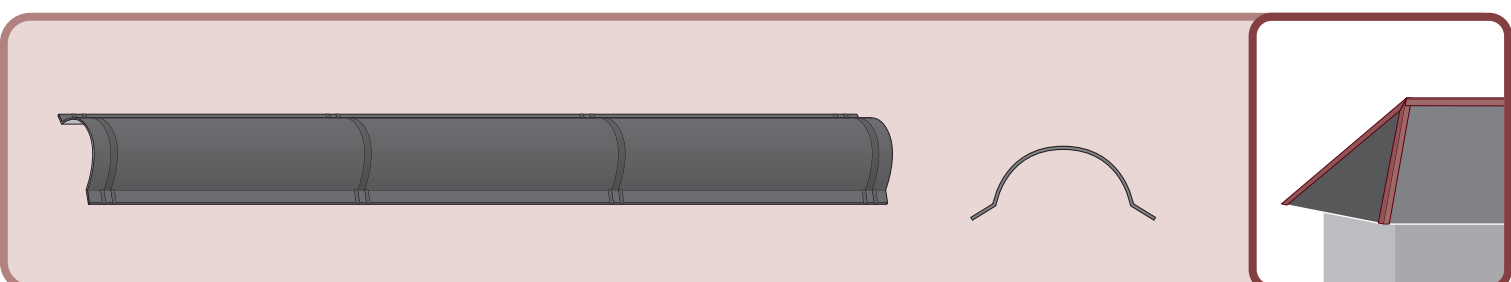

1

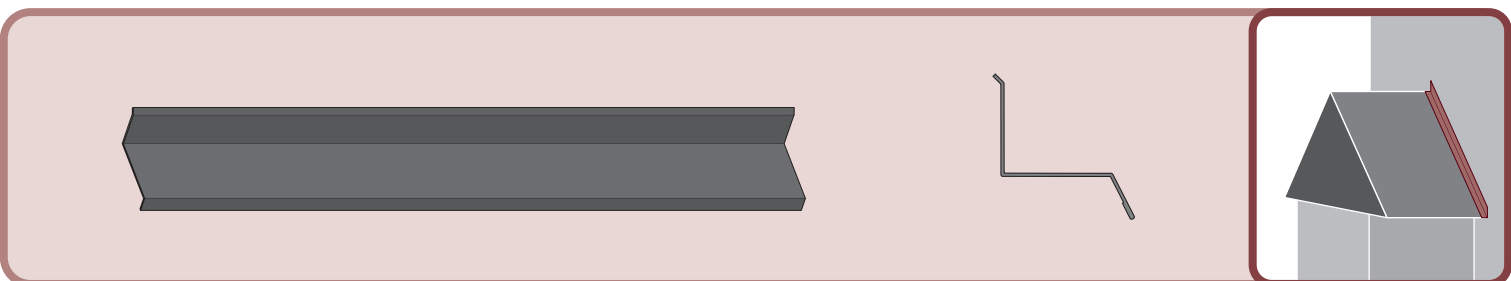
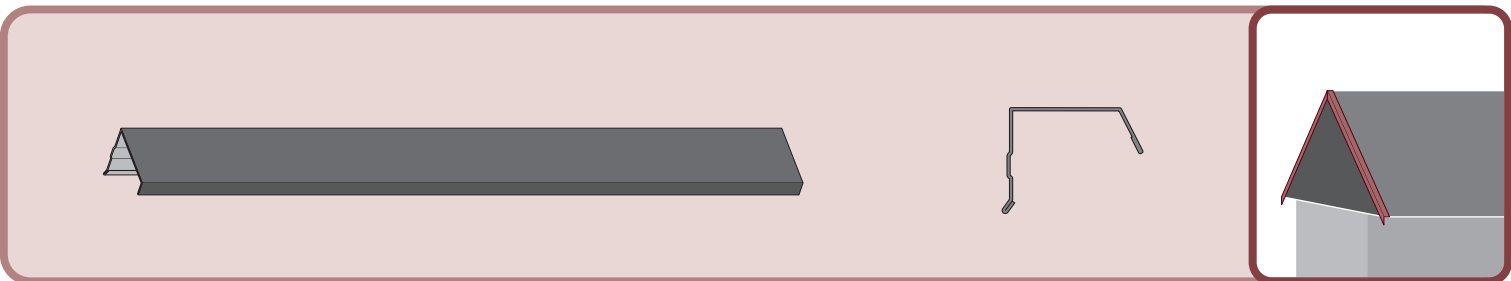
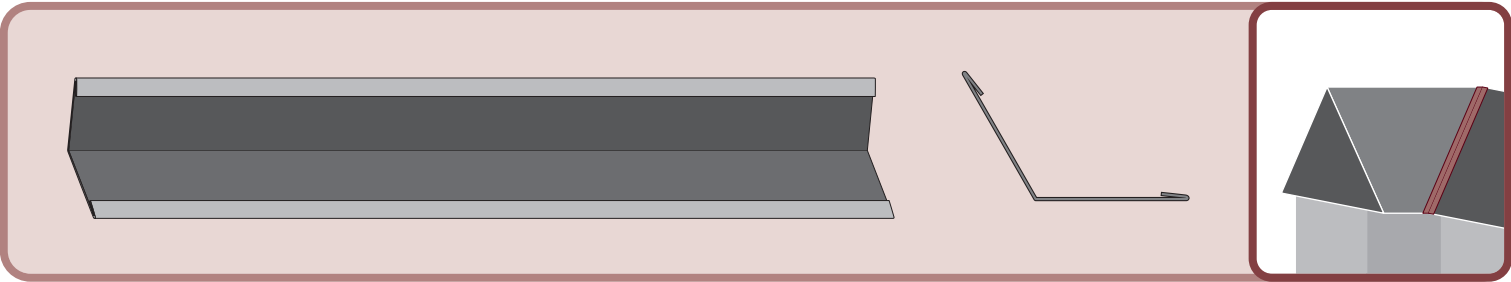
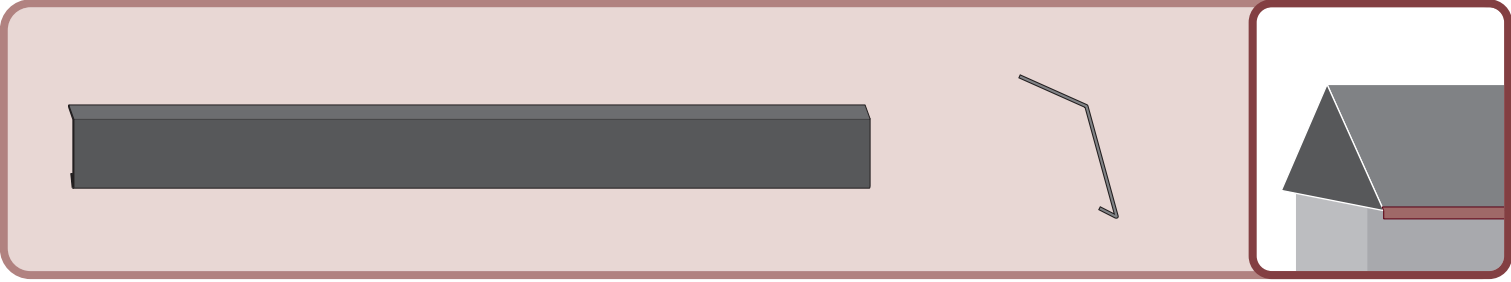
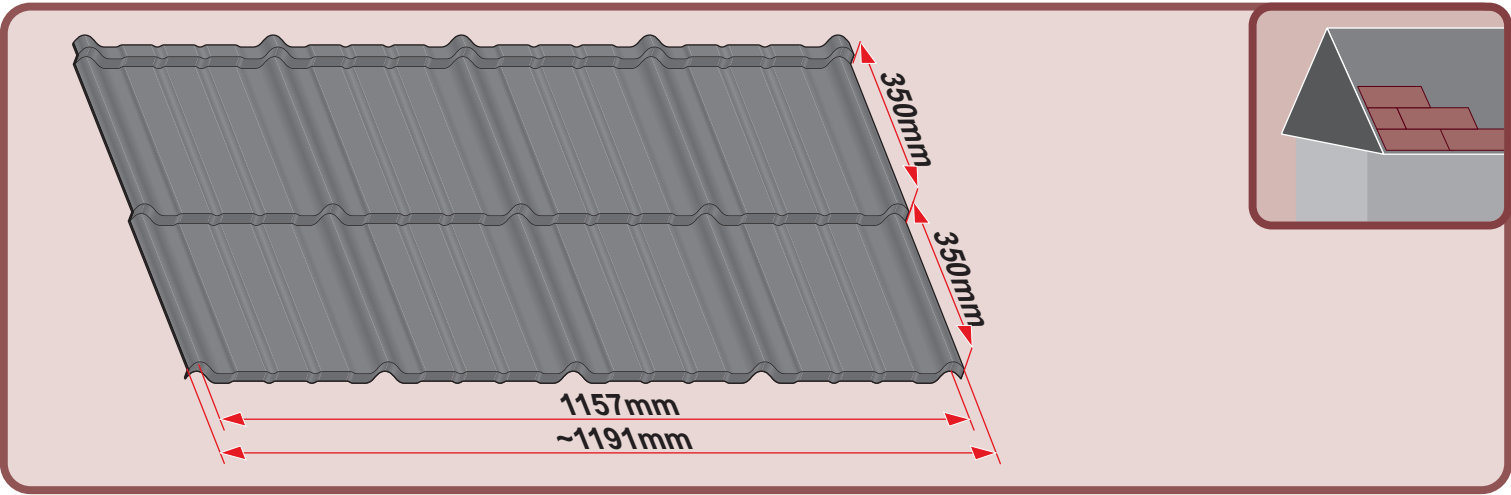
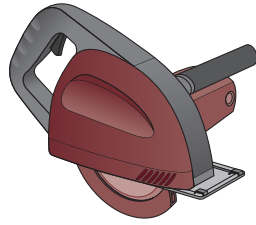
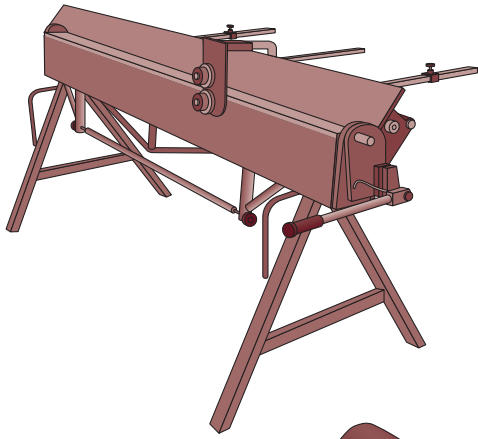

max 4000 r/min

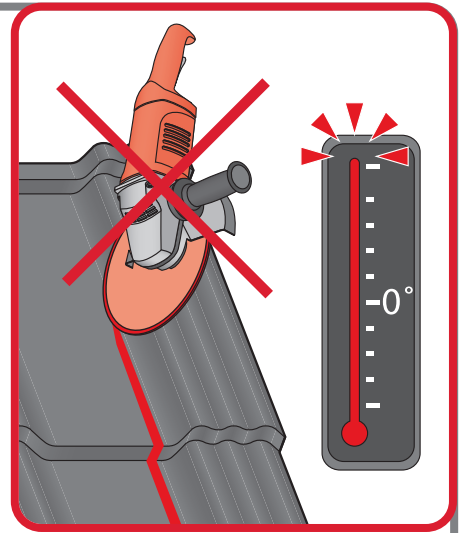
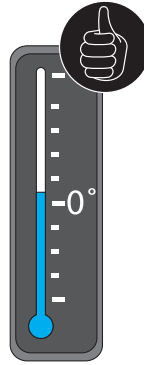
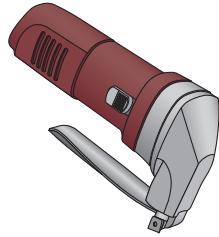

2

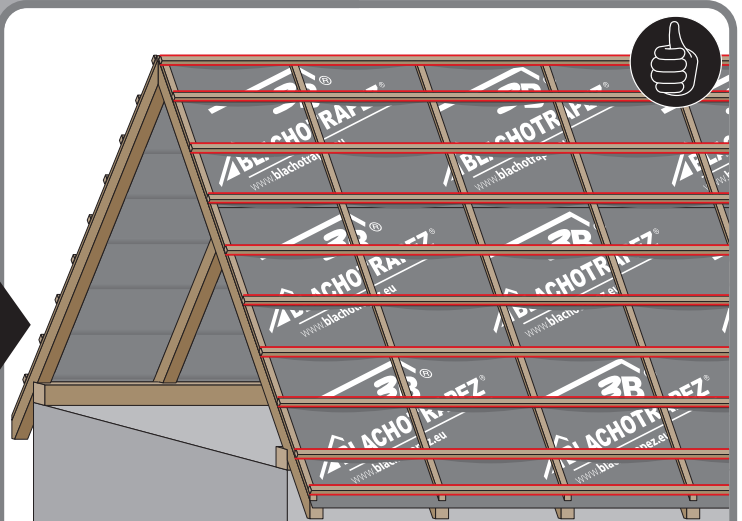
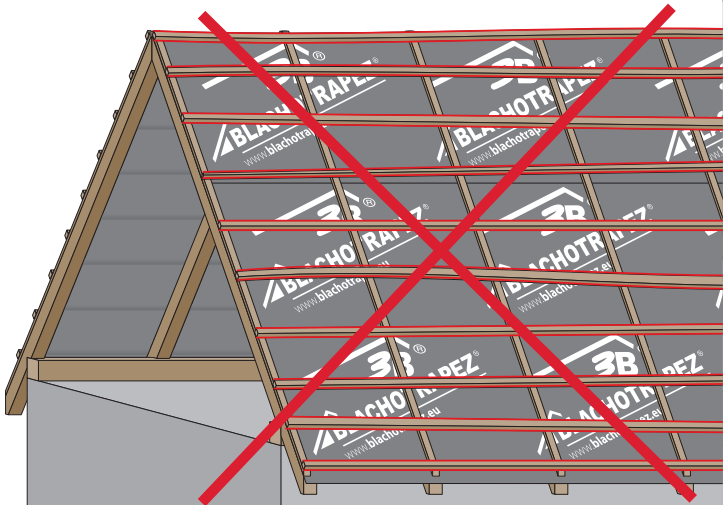
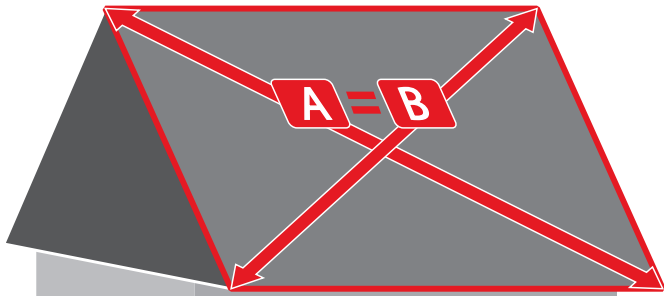

3

3a

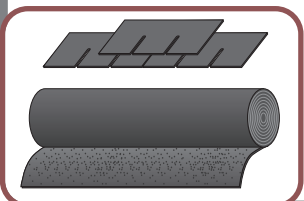
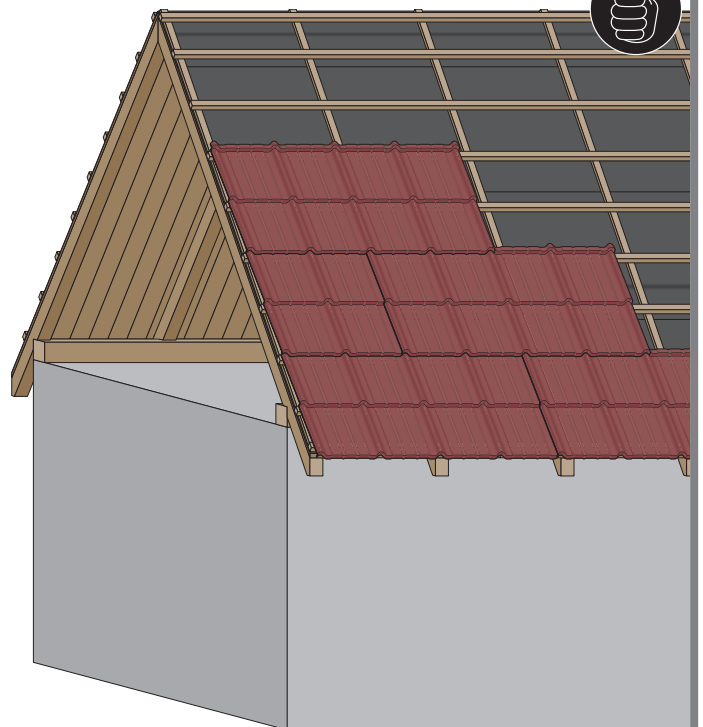
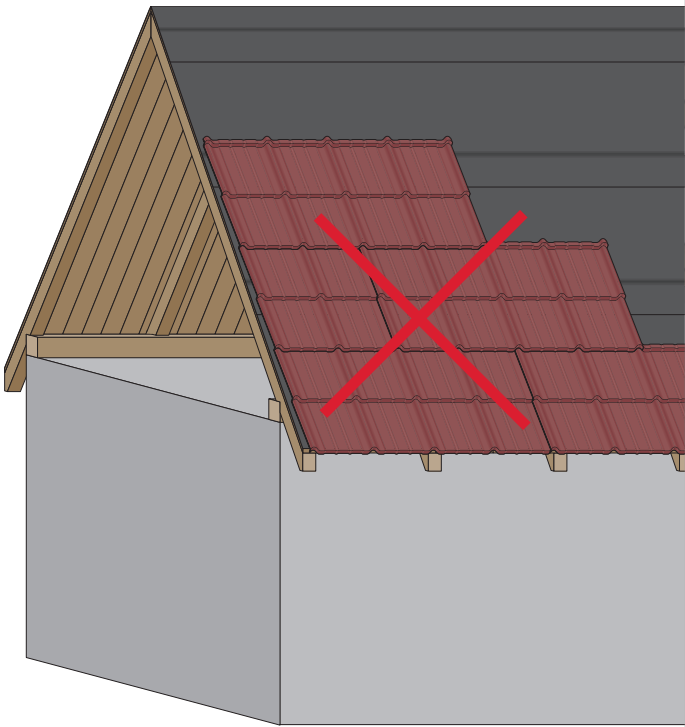
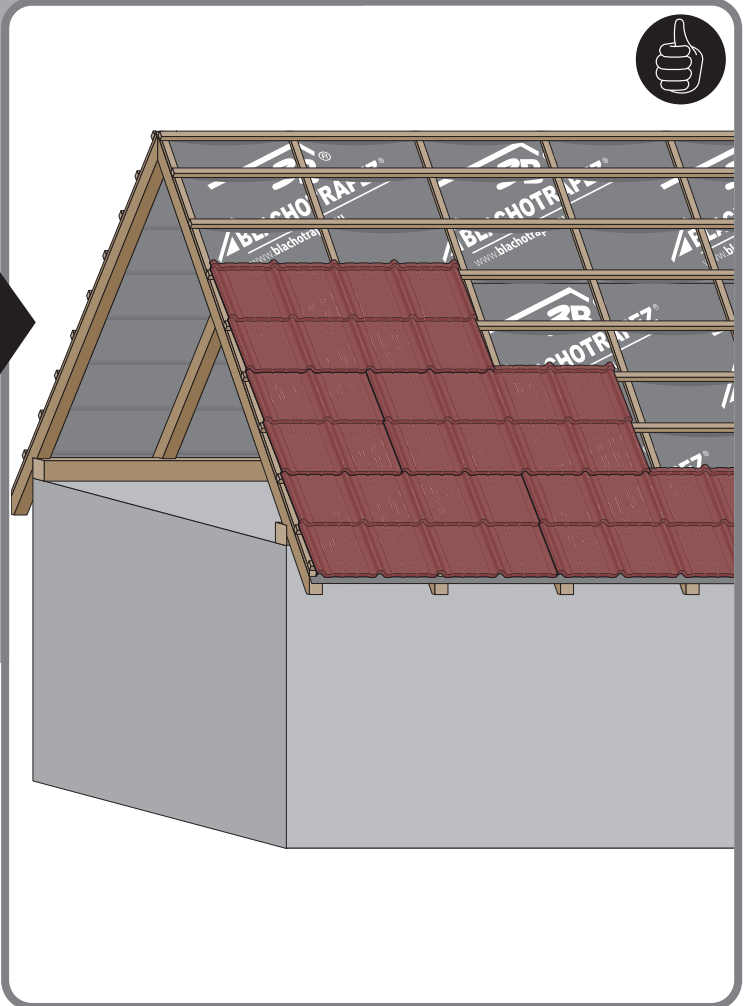
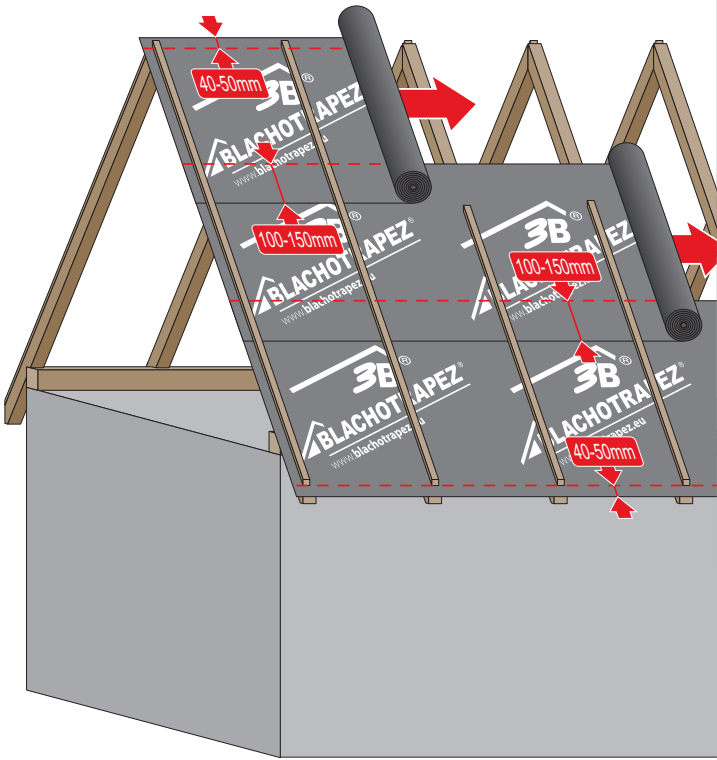

3b

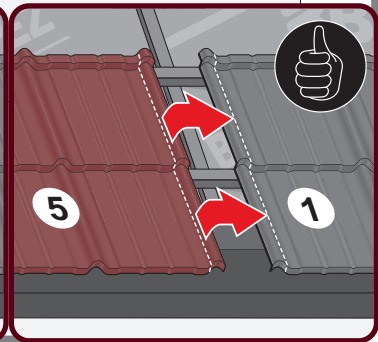
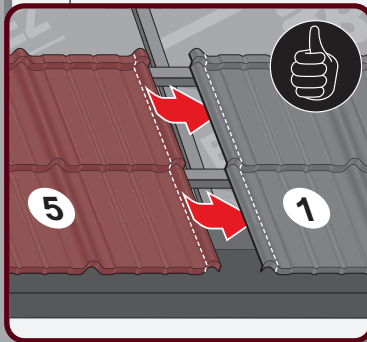
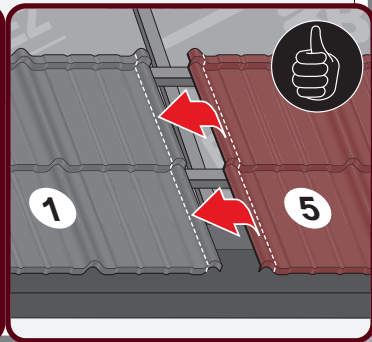
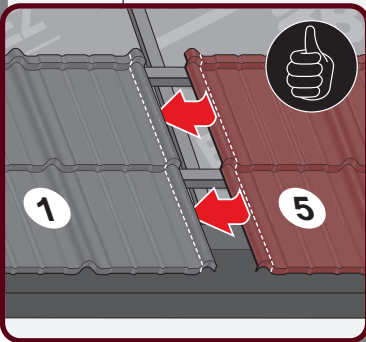
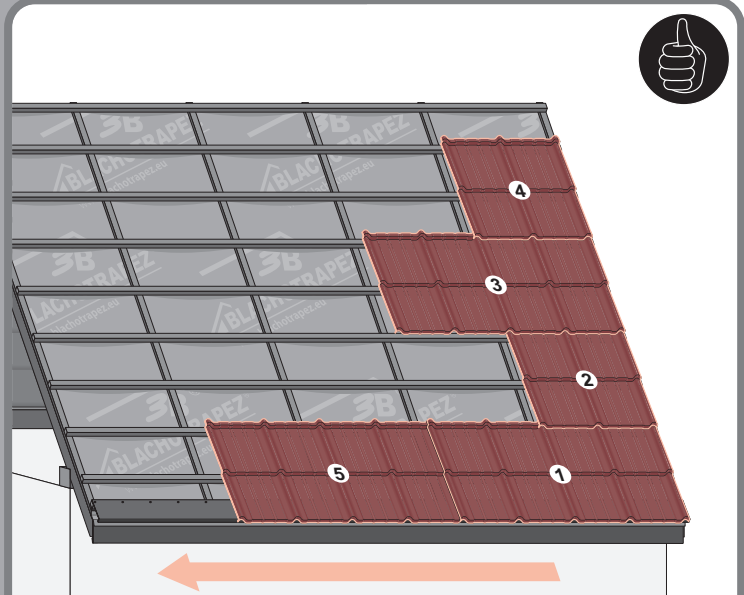
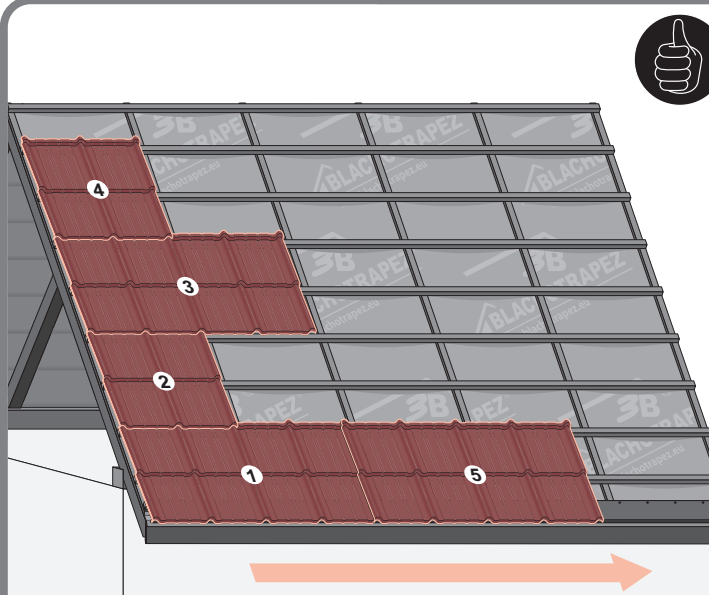
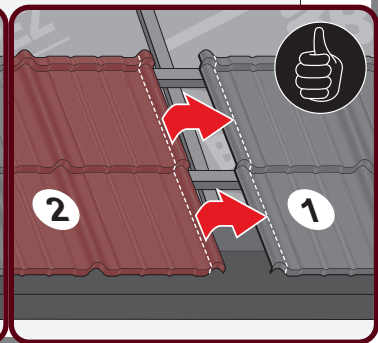
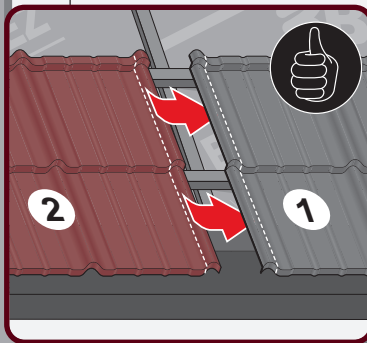
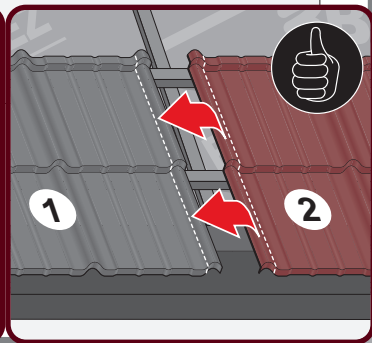
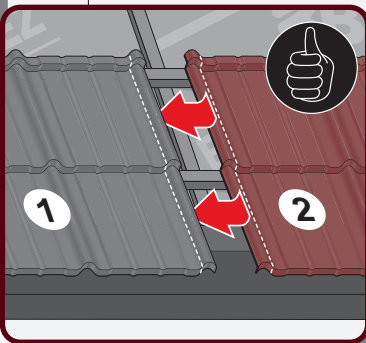
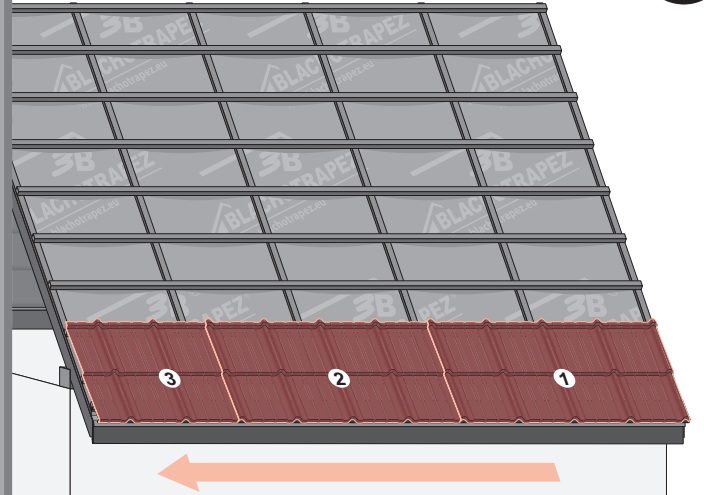
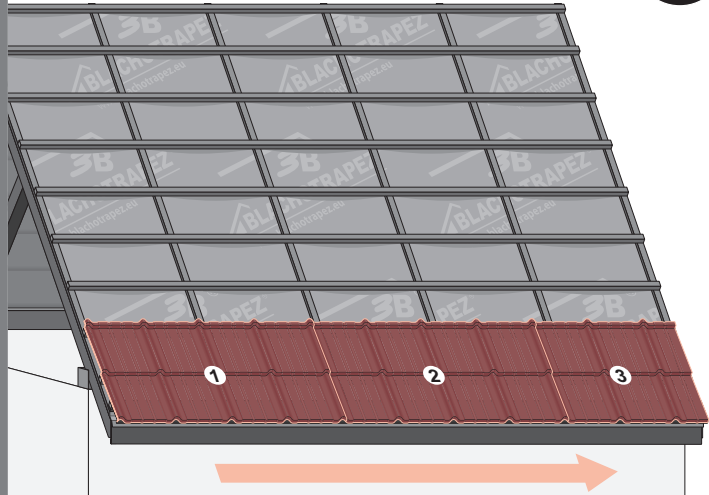

3c

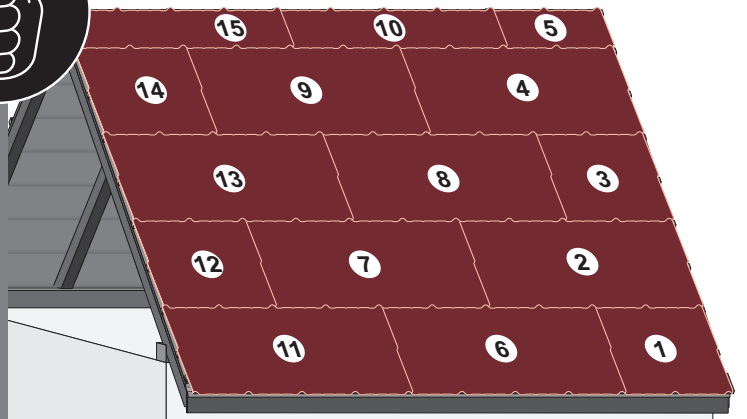
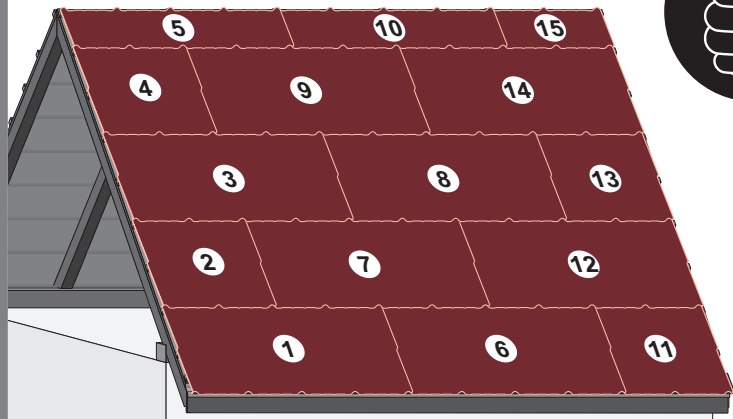

3d

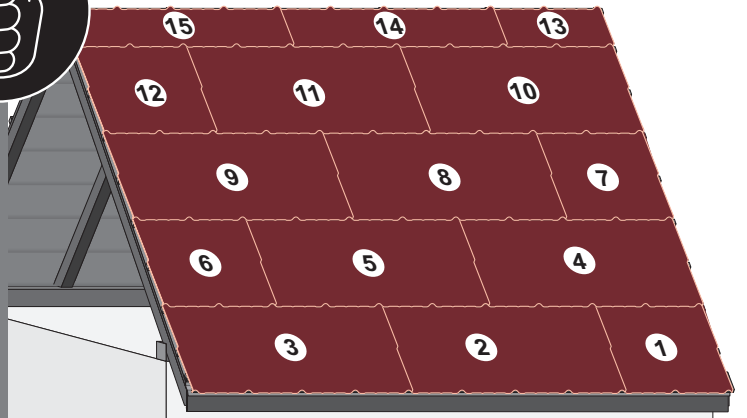

3e

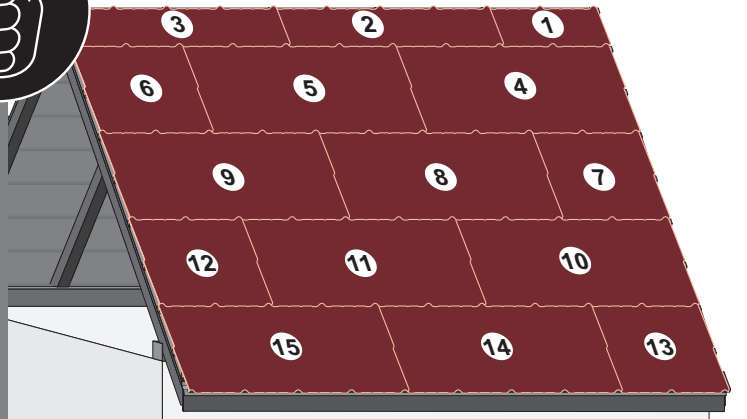
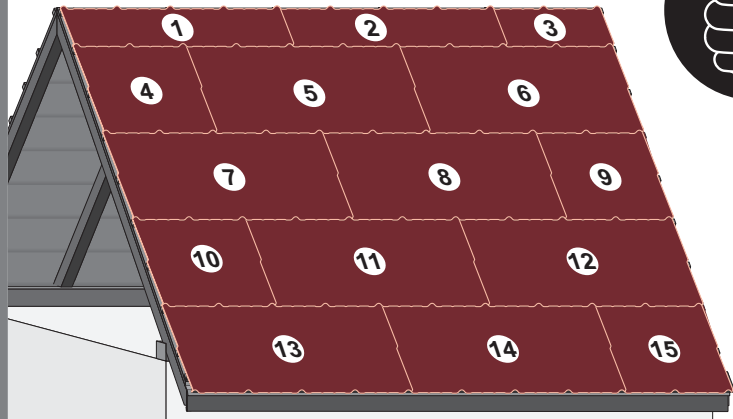

4

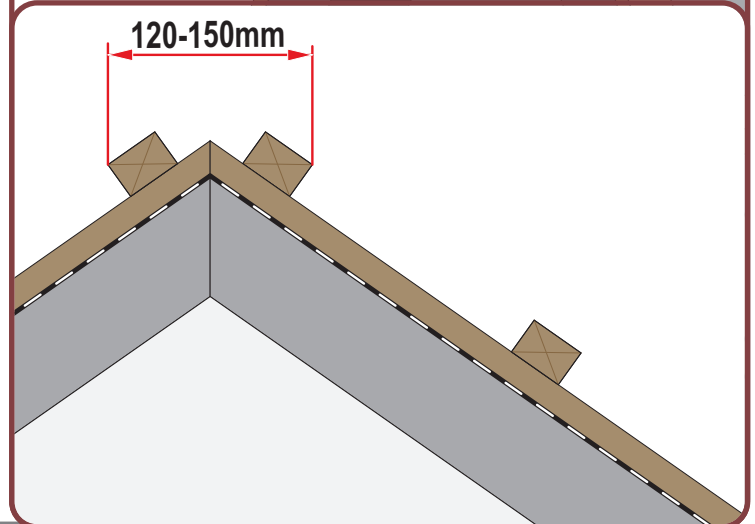
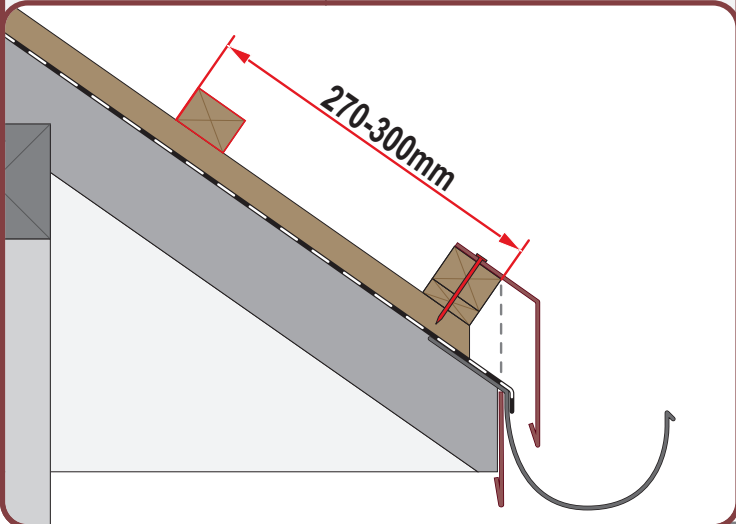
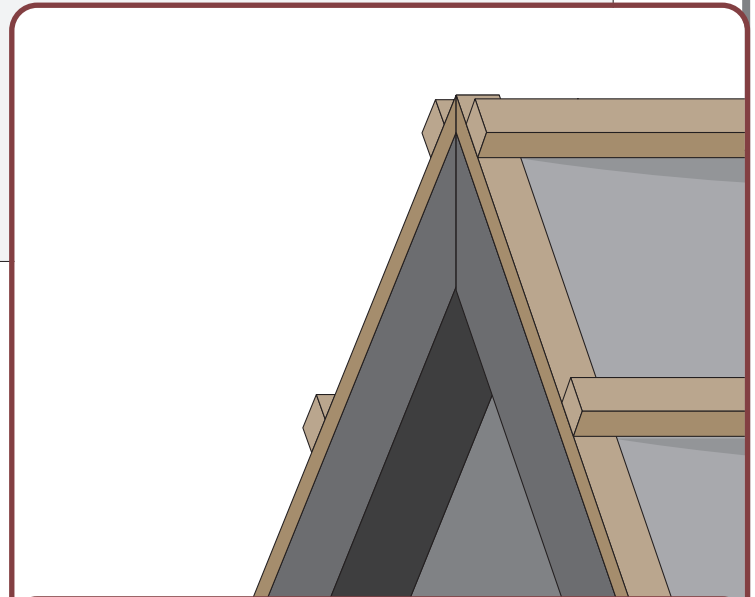
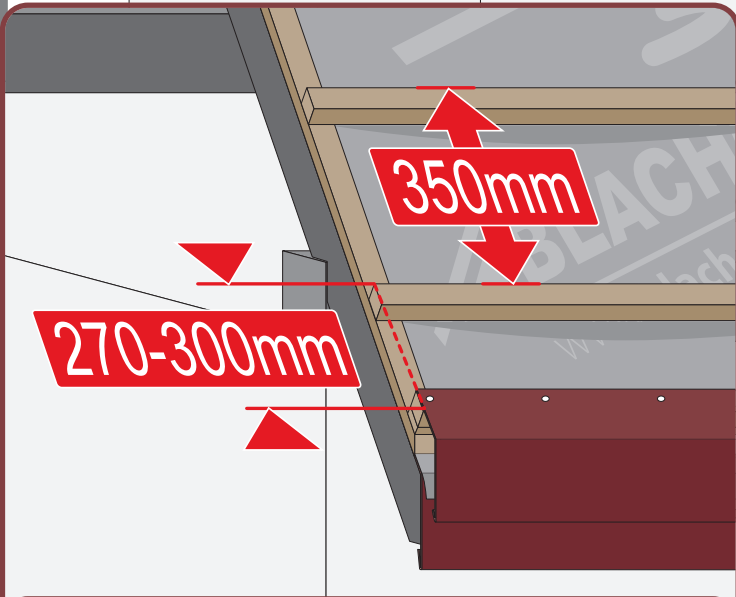
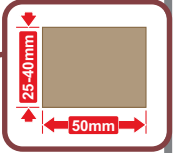
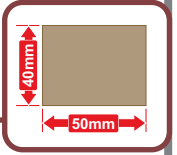
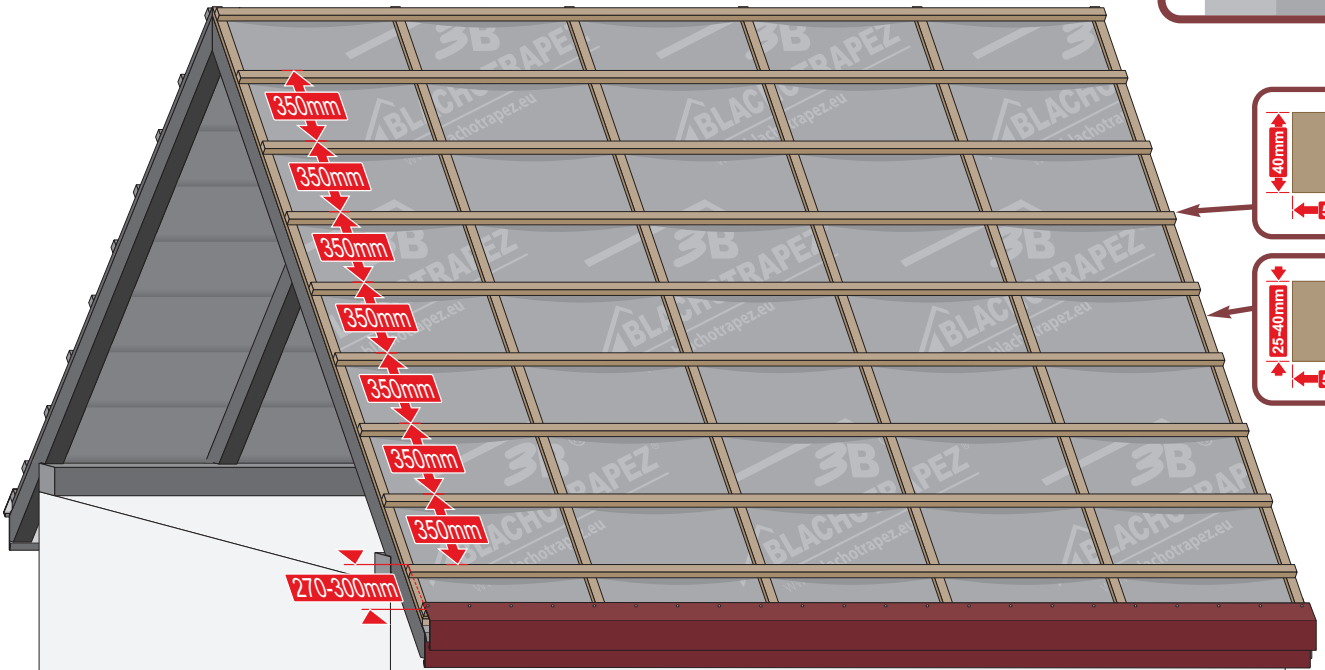

5a

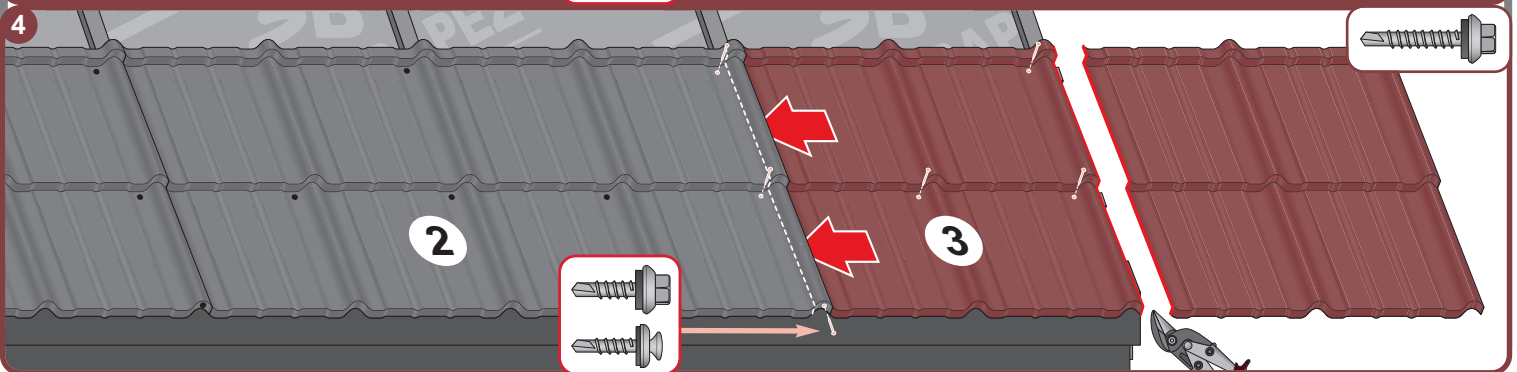
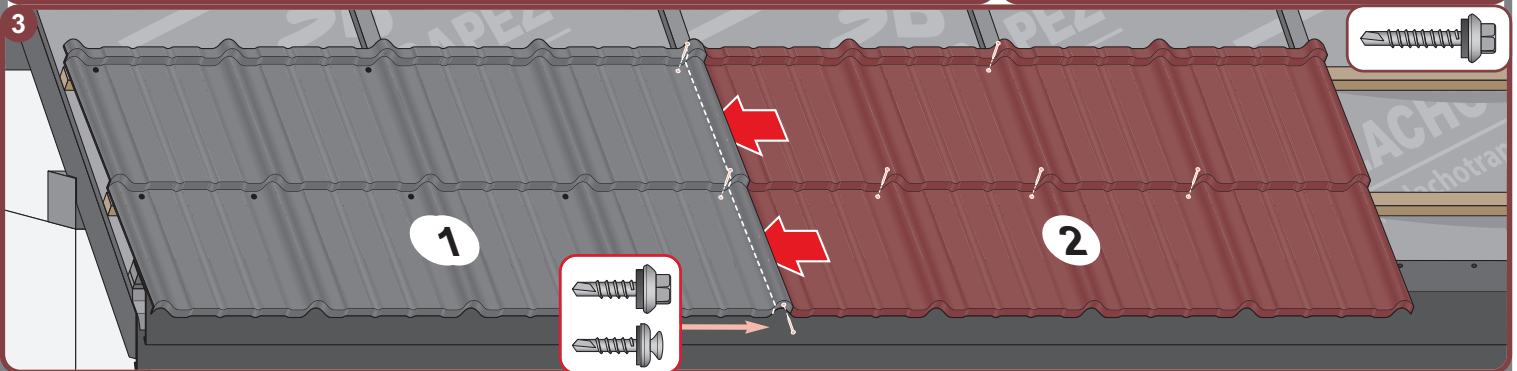
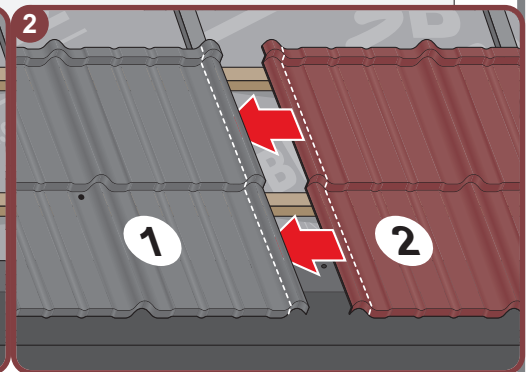
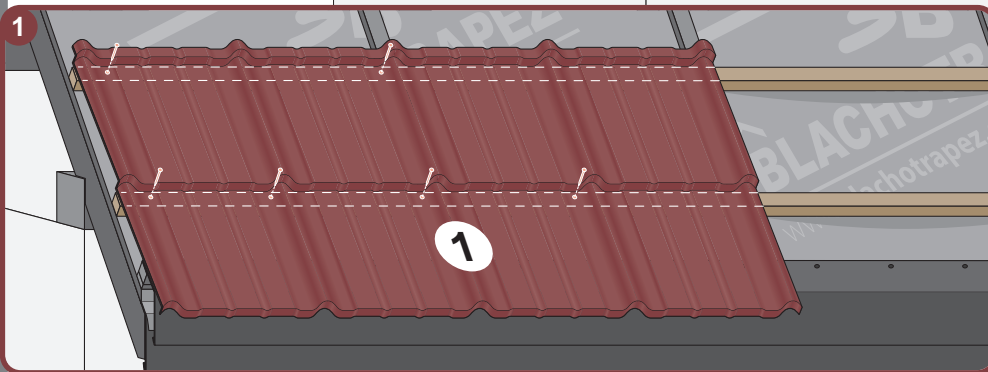
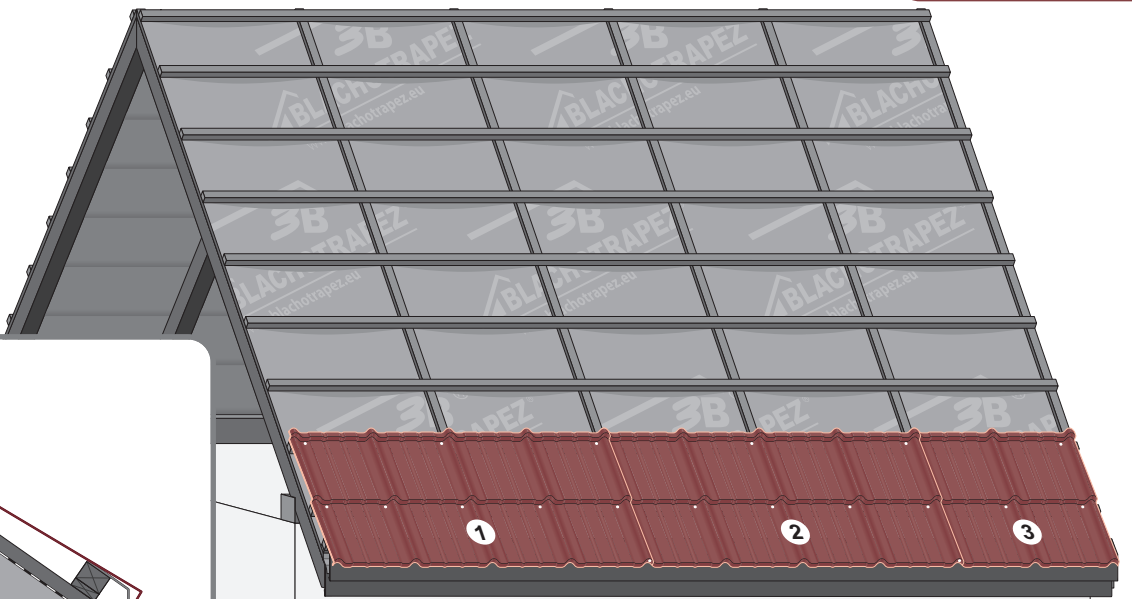
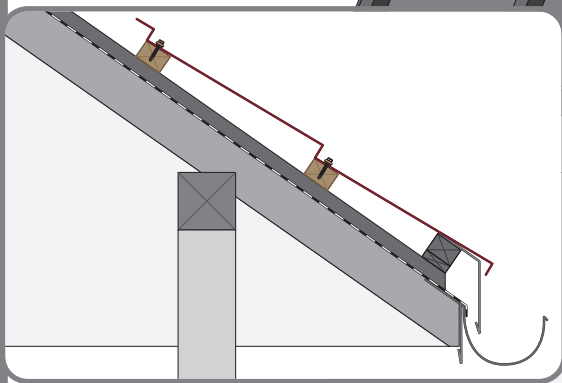
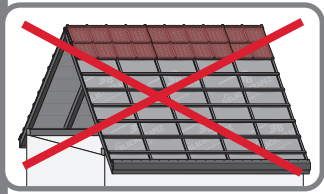
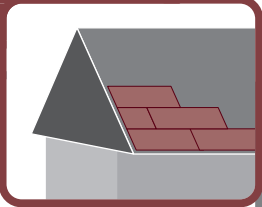

5b

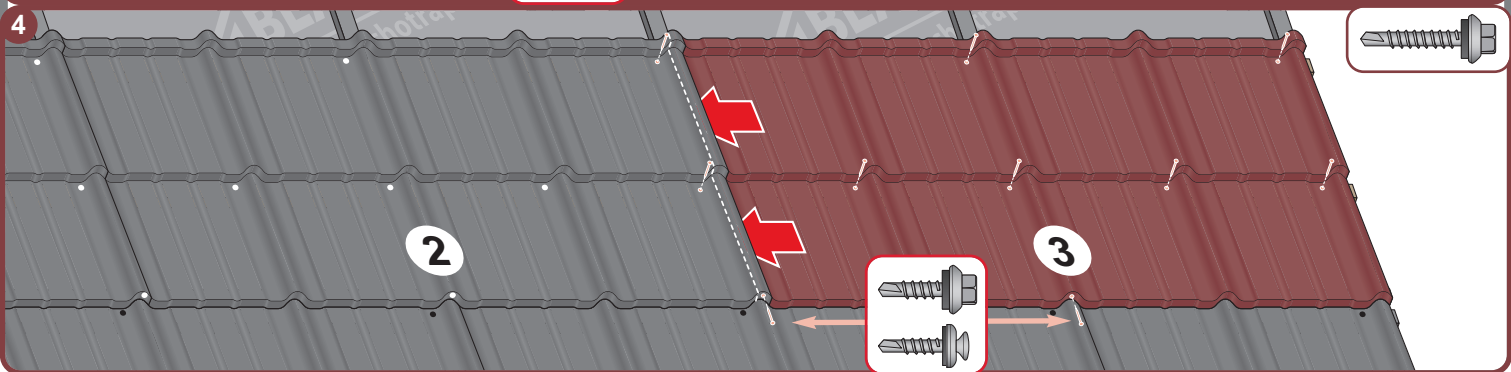
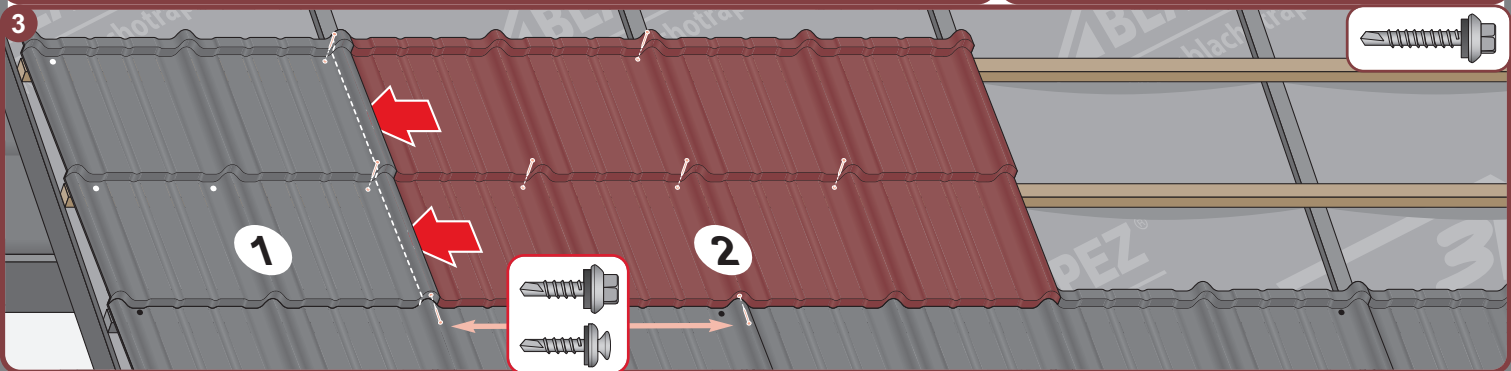
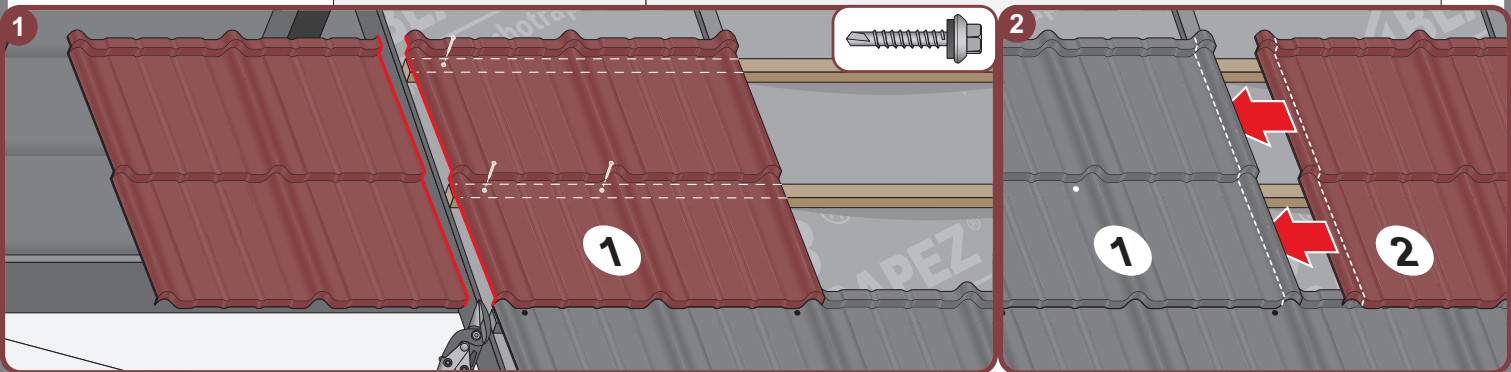
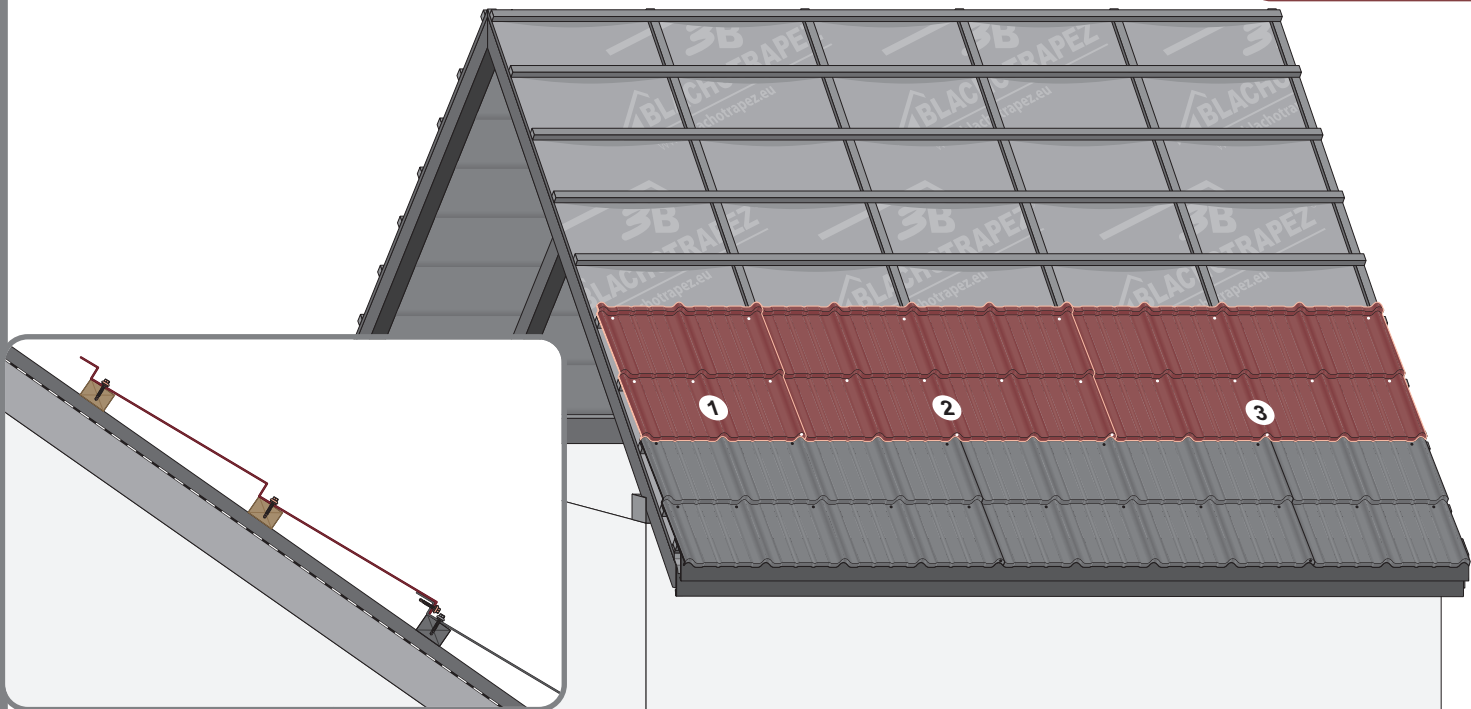
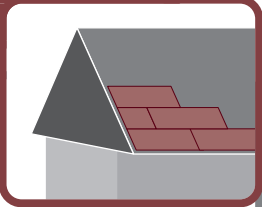

5c

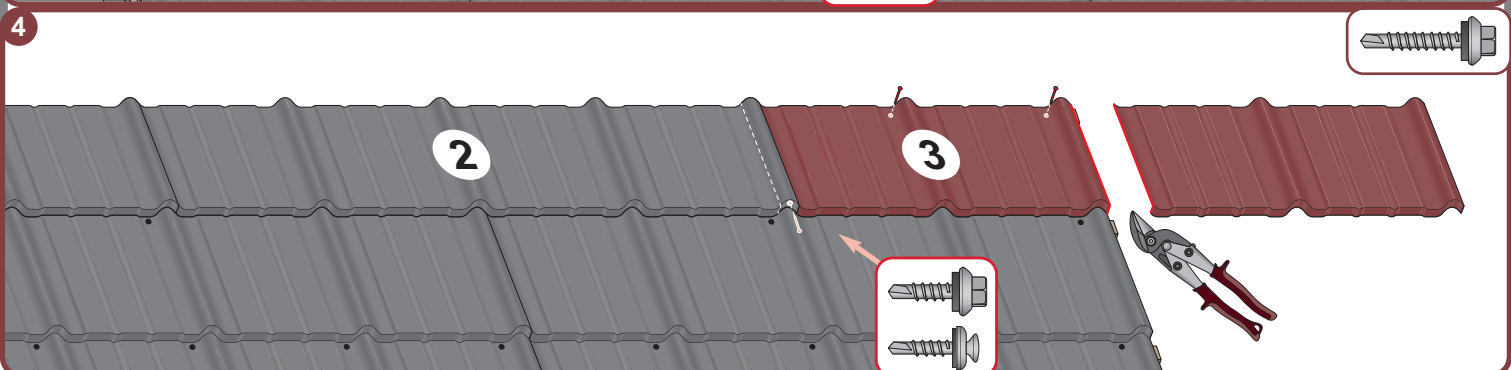
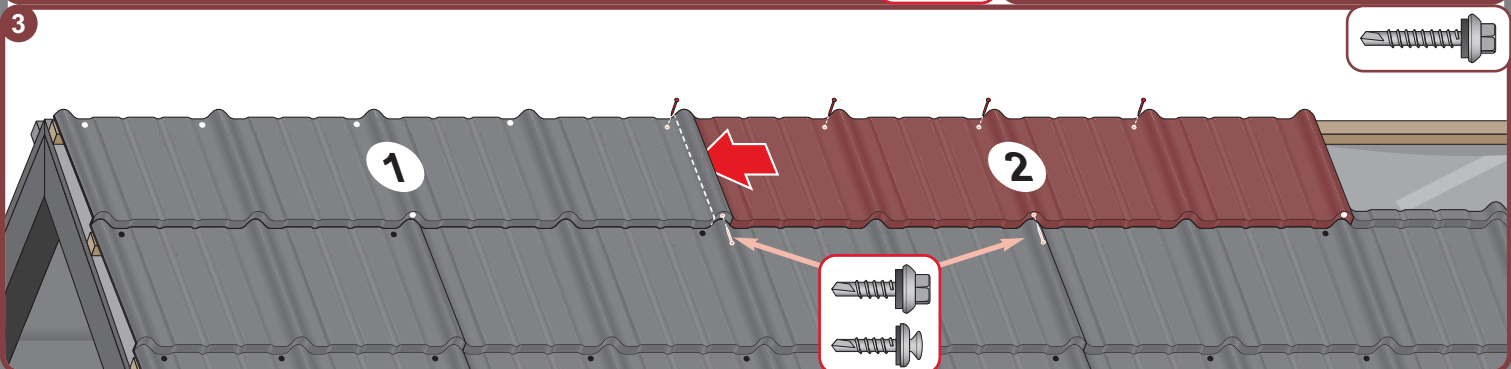
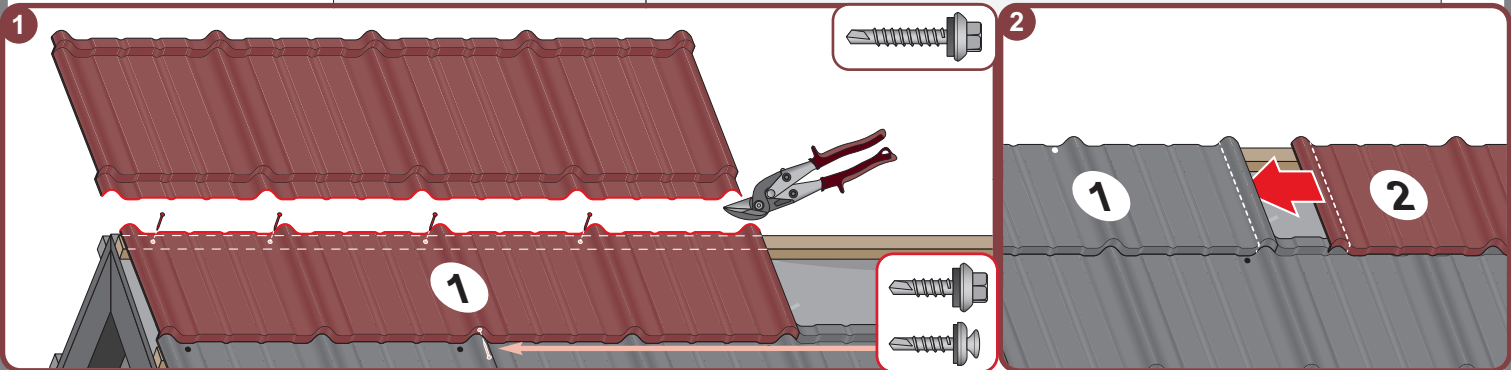
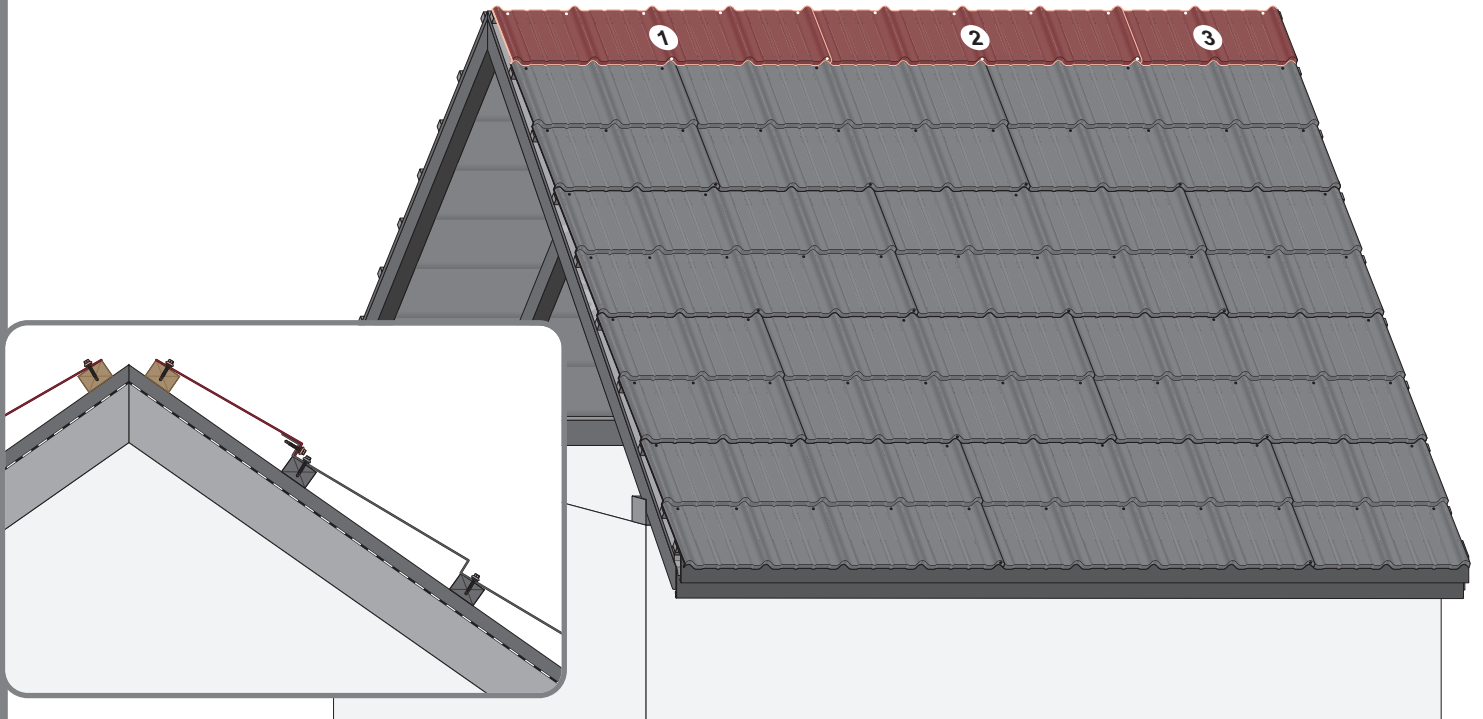
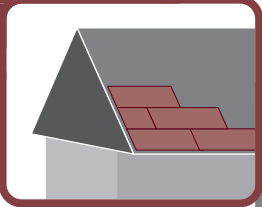

5d

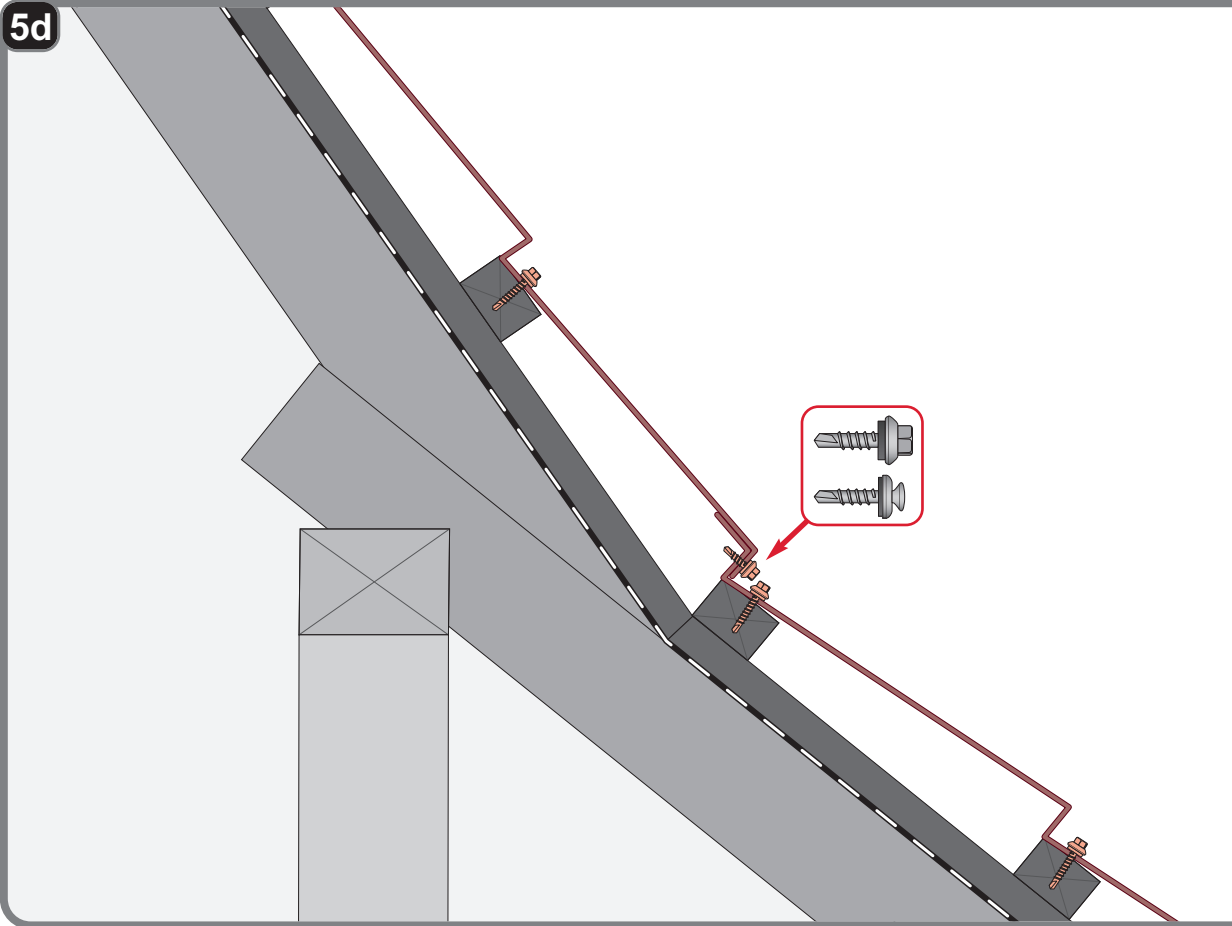
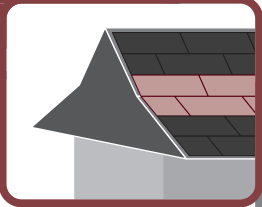

5e

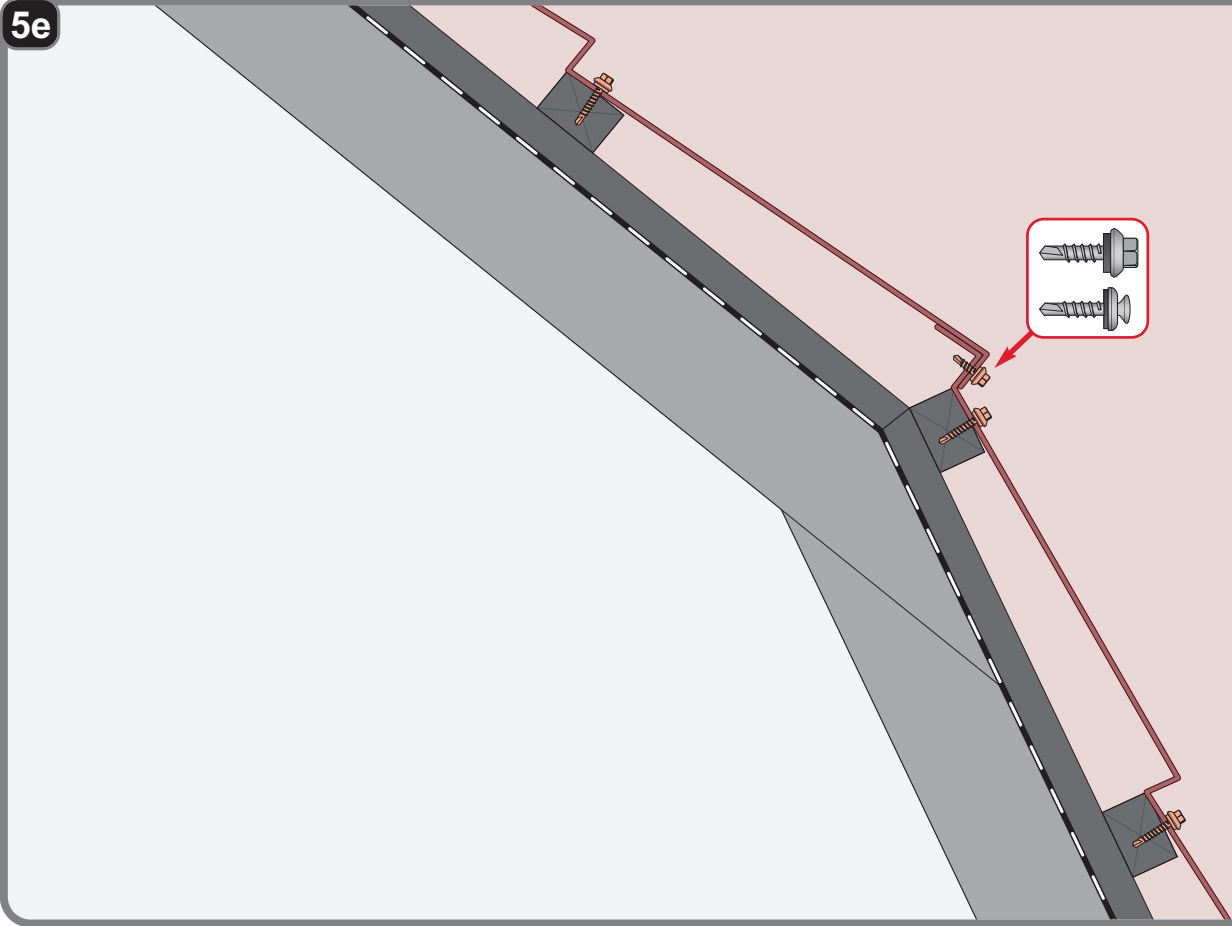
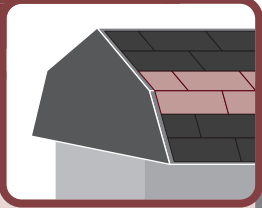

6a

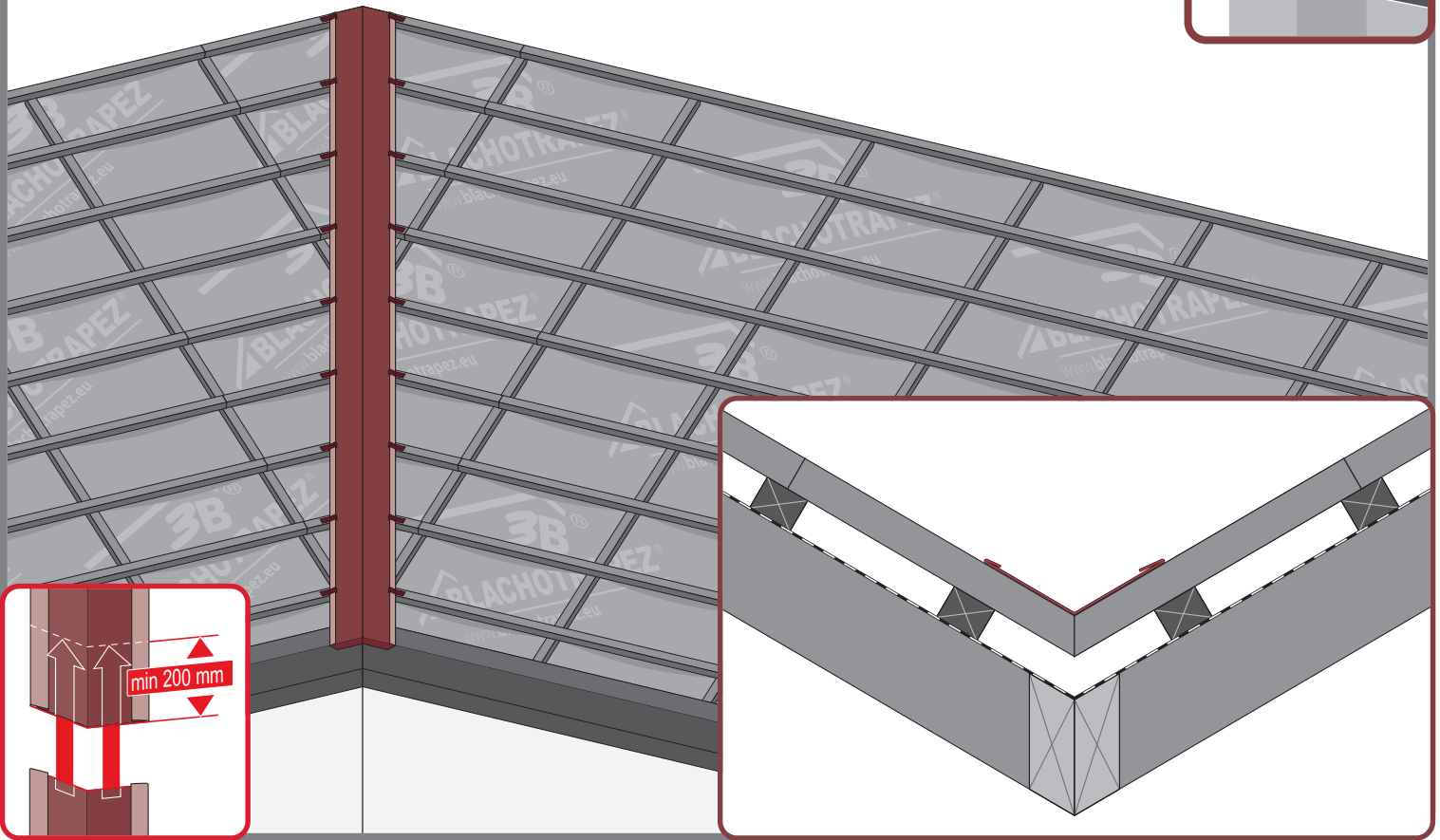

6b

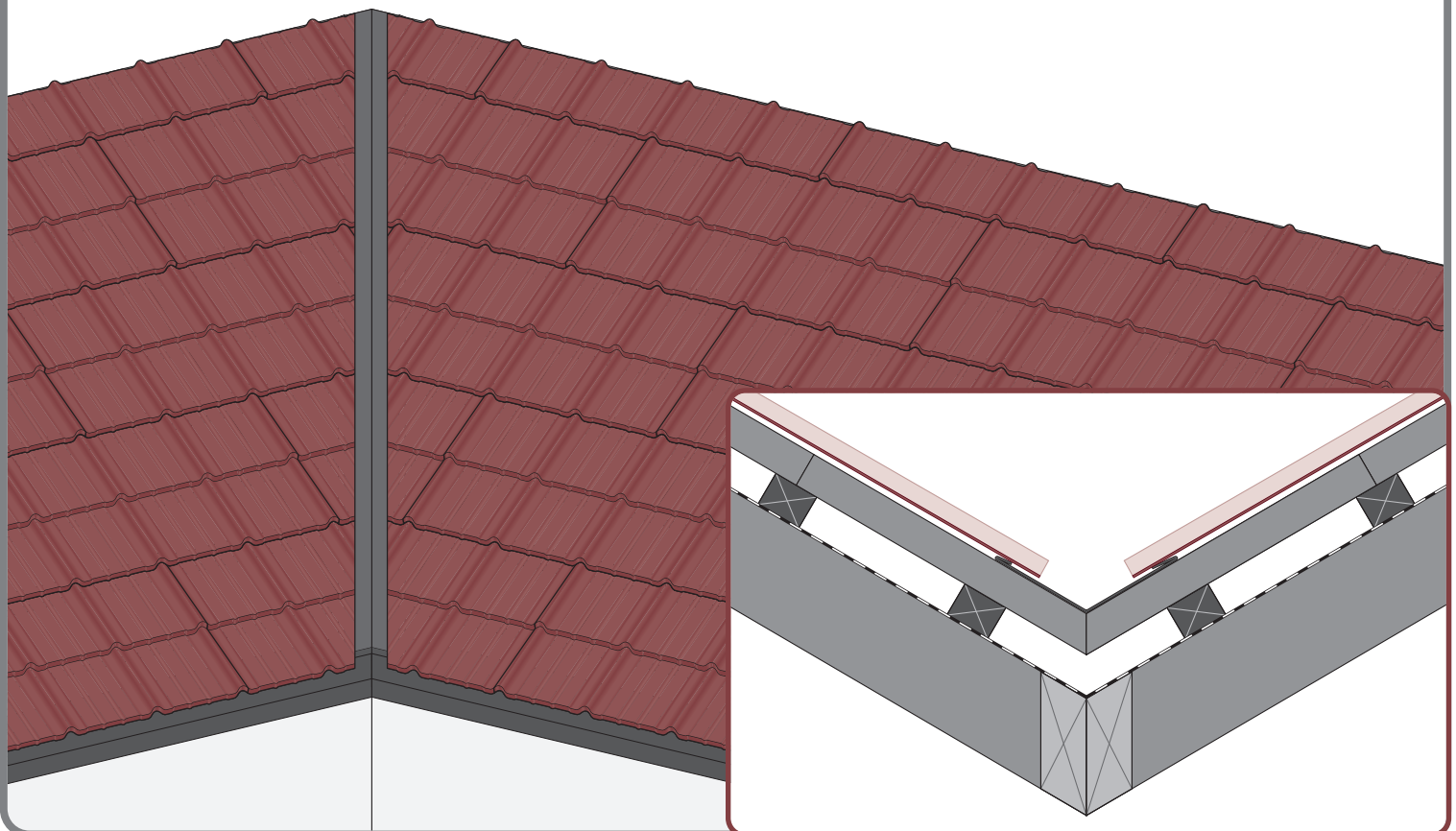

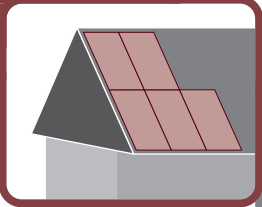

7a

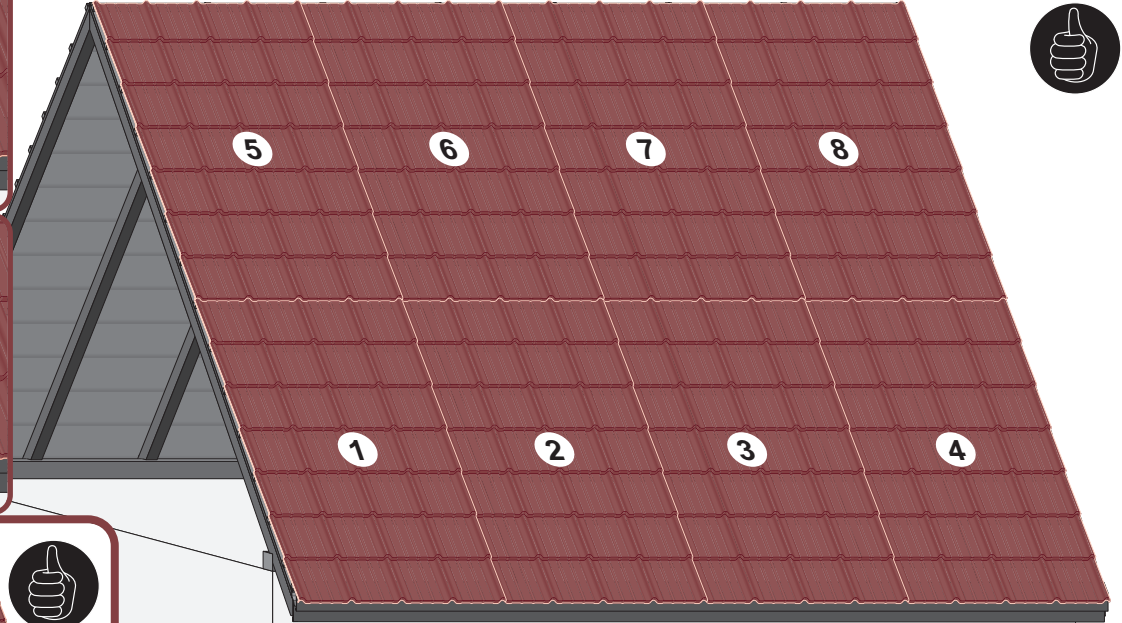
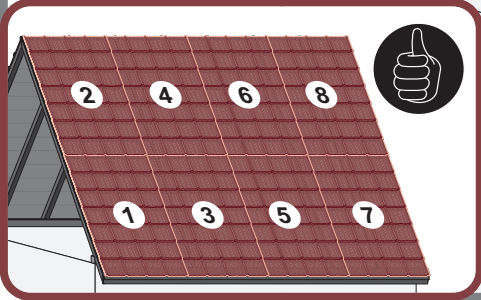
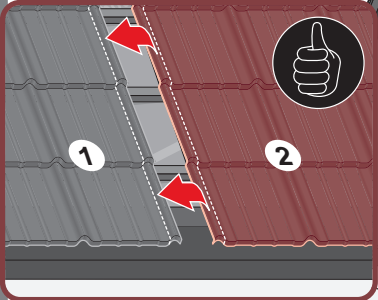
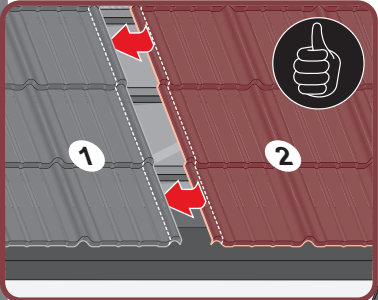

7b

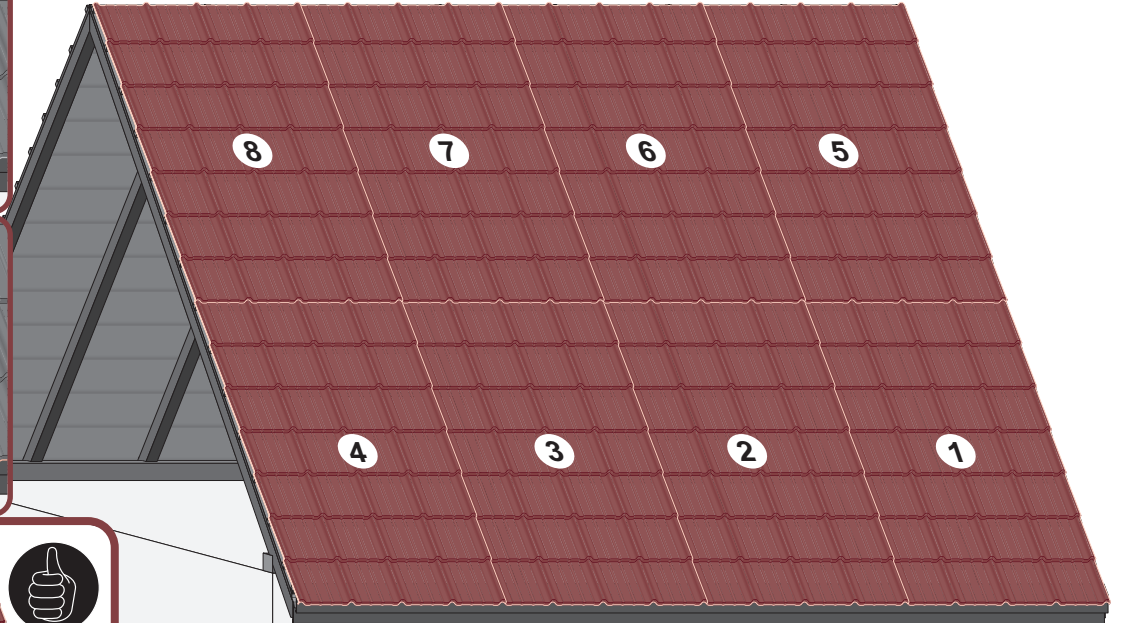
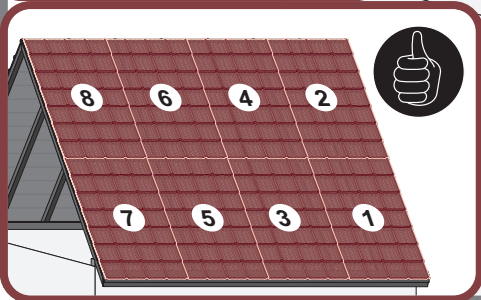
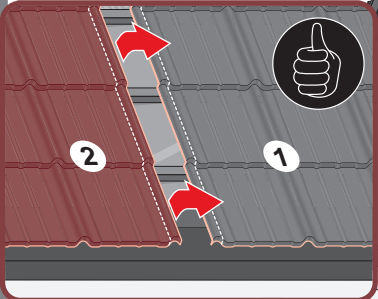
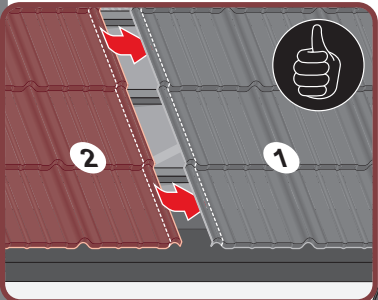

8a

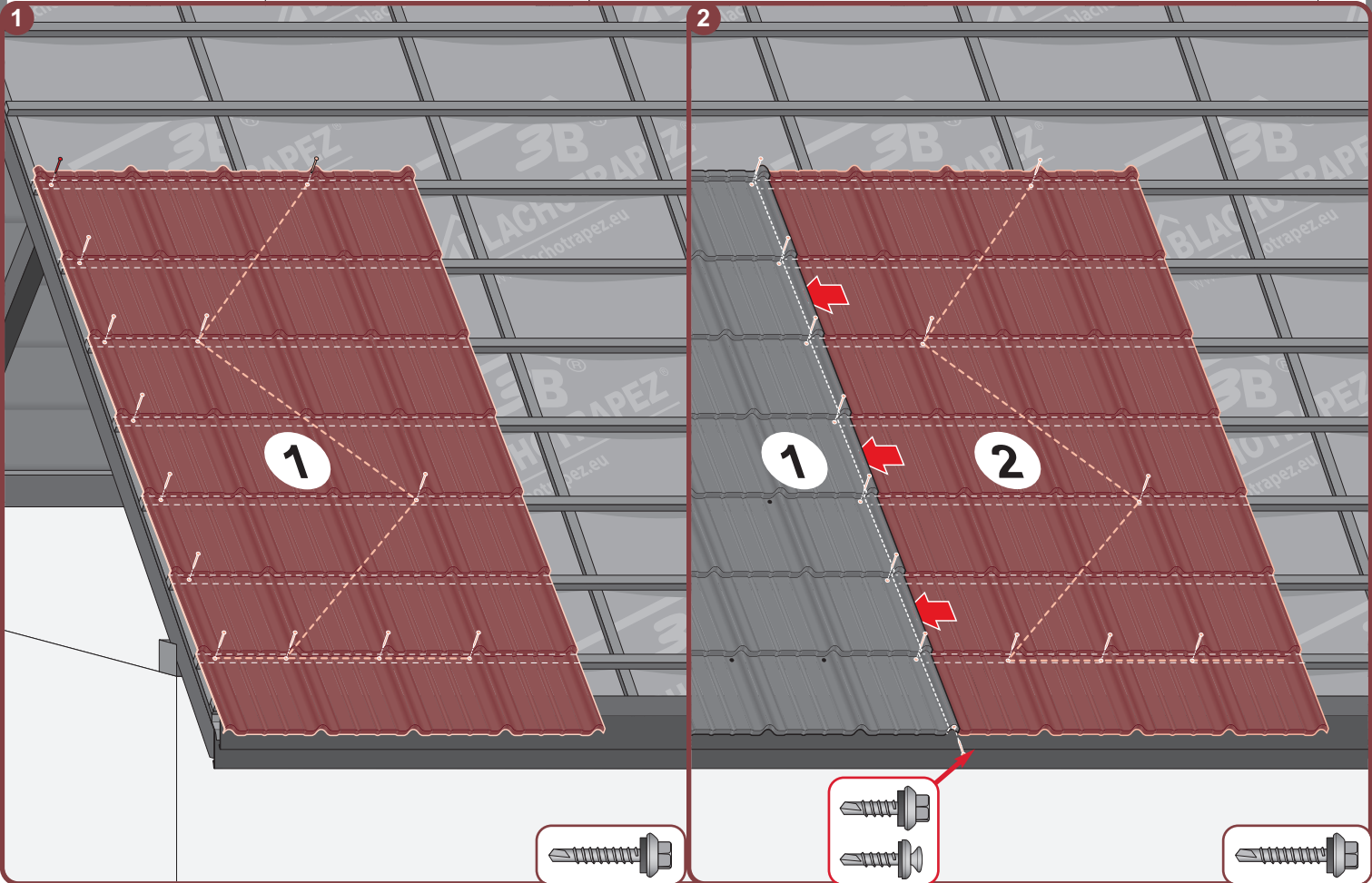
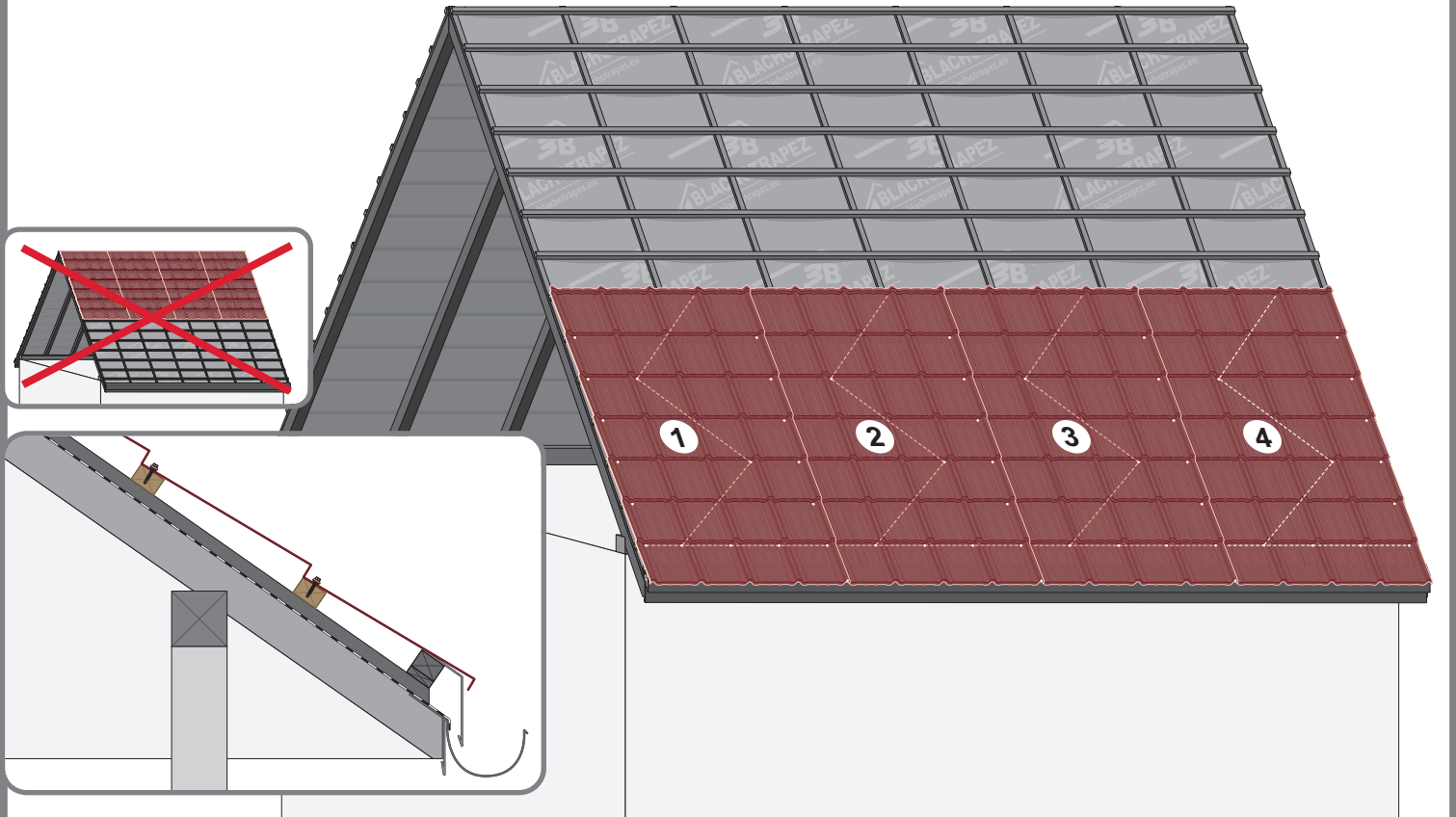
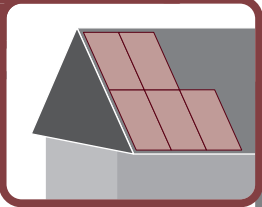

8b

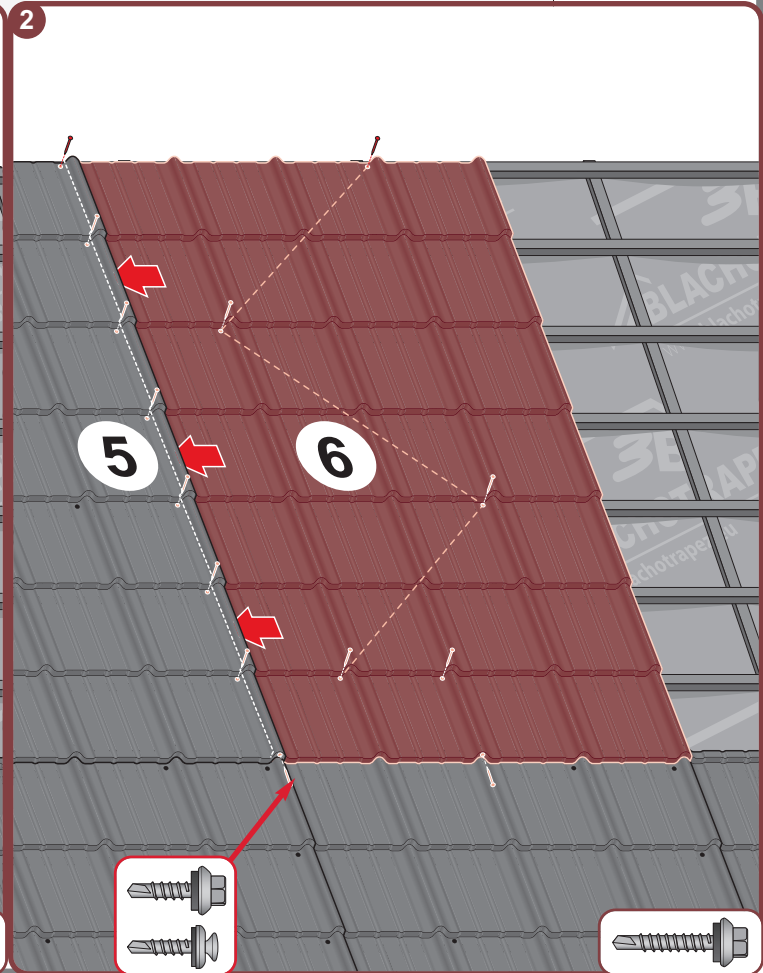
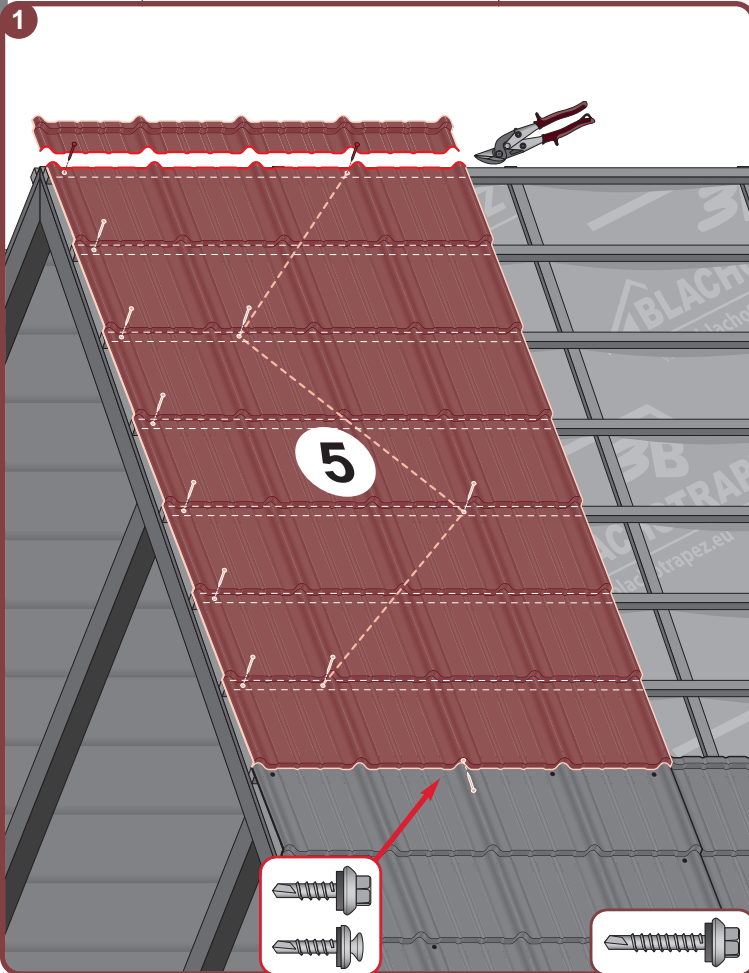
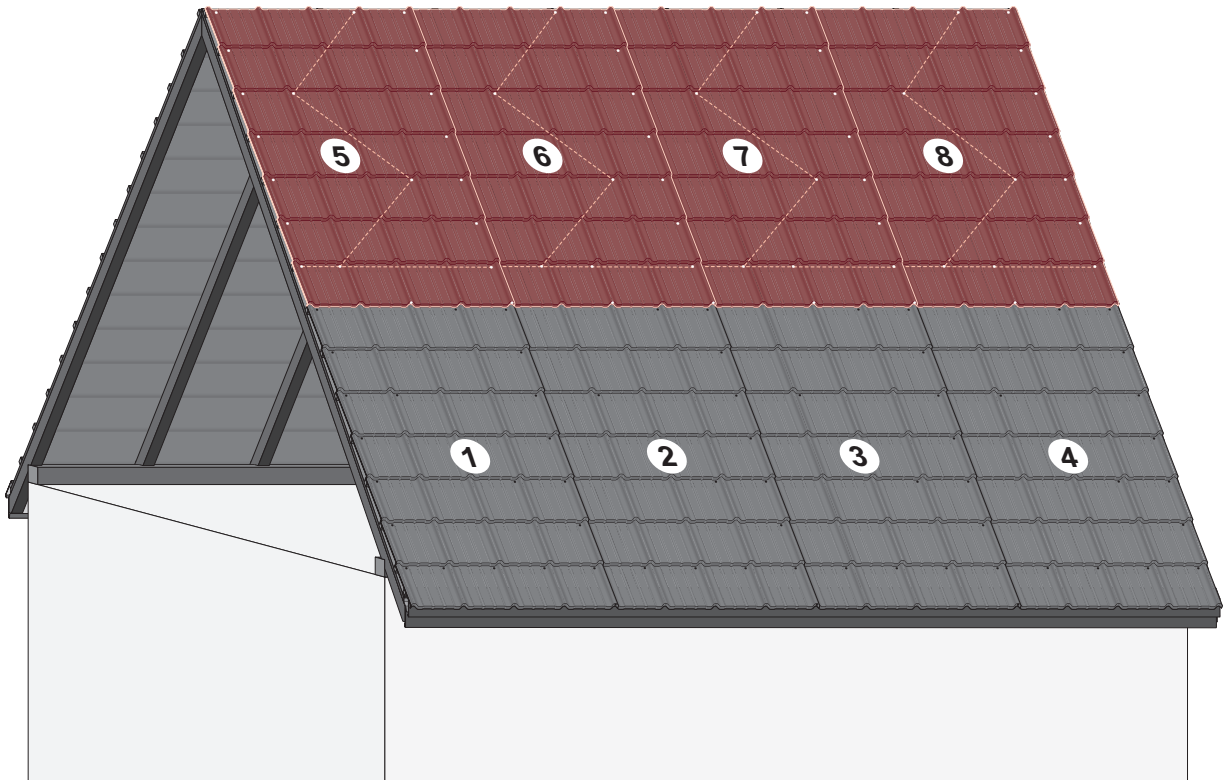
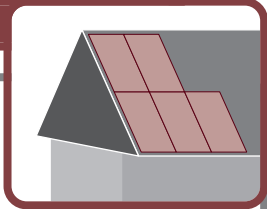

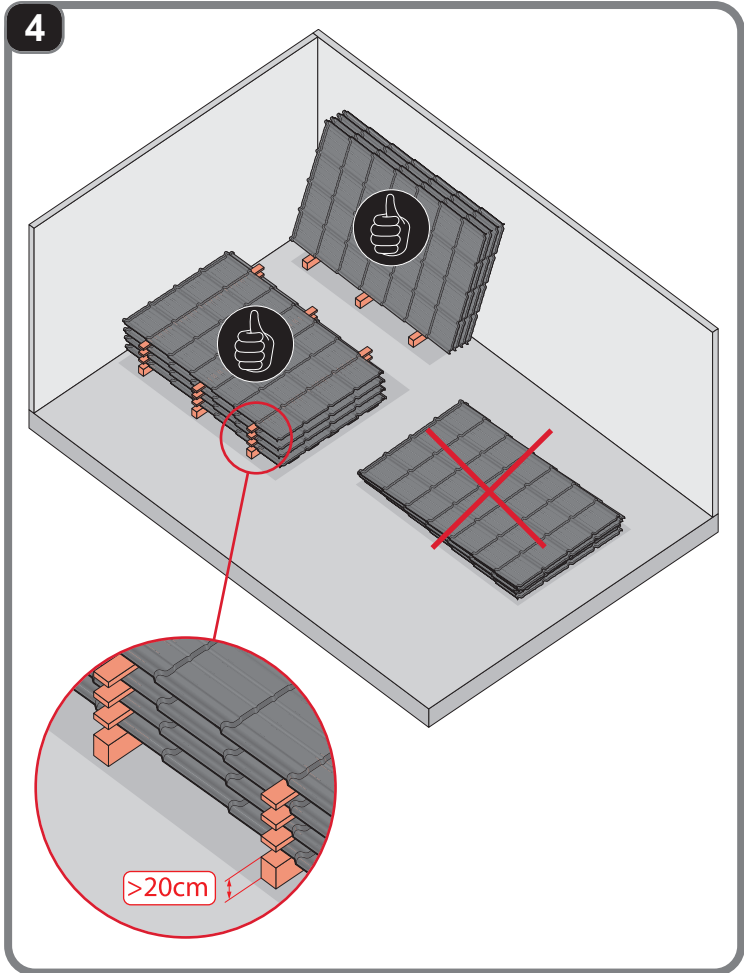
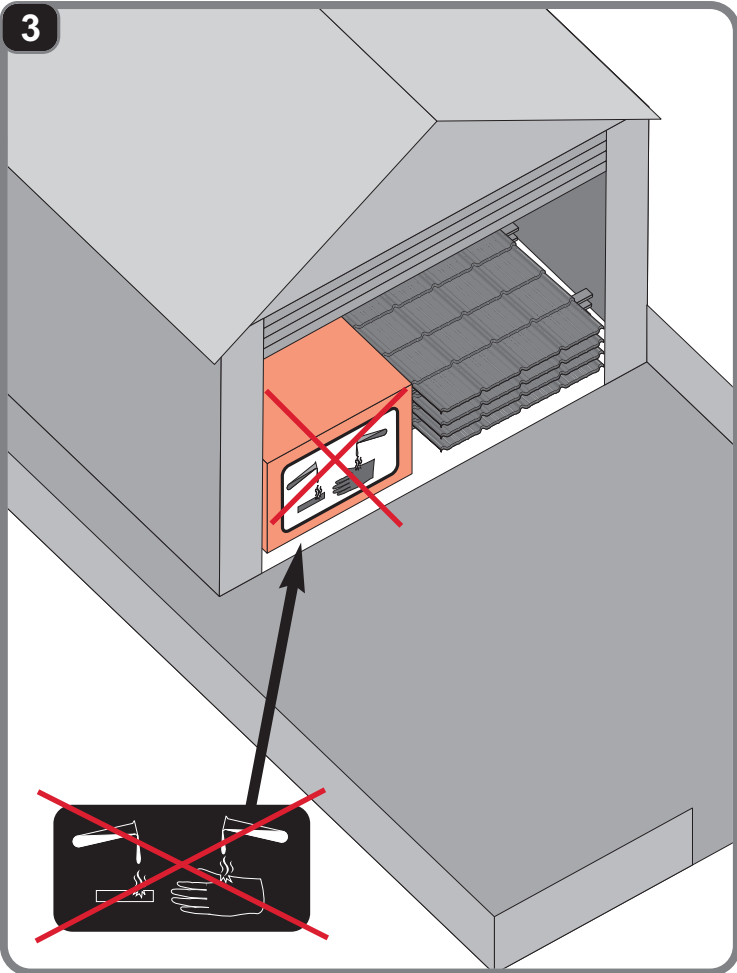
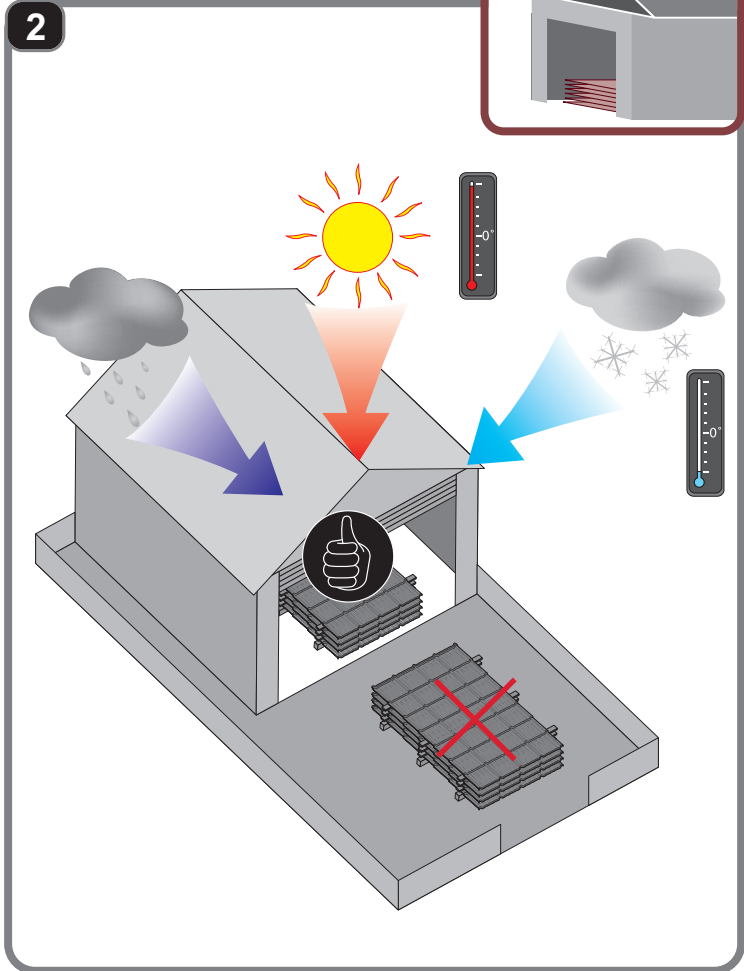
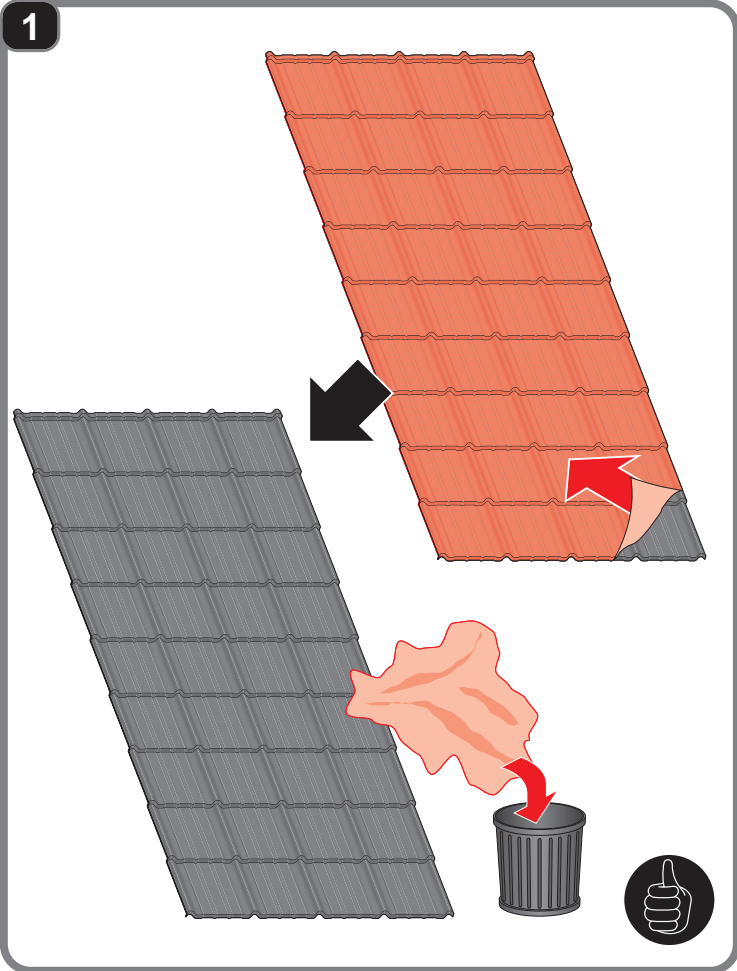

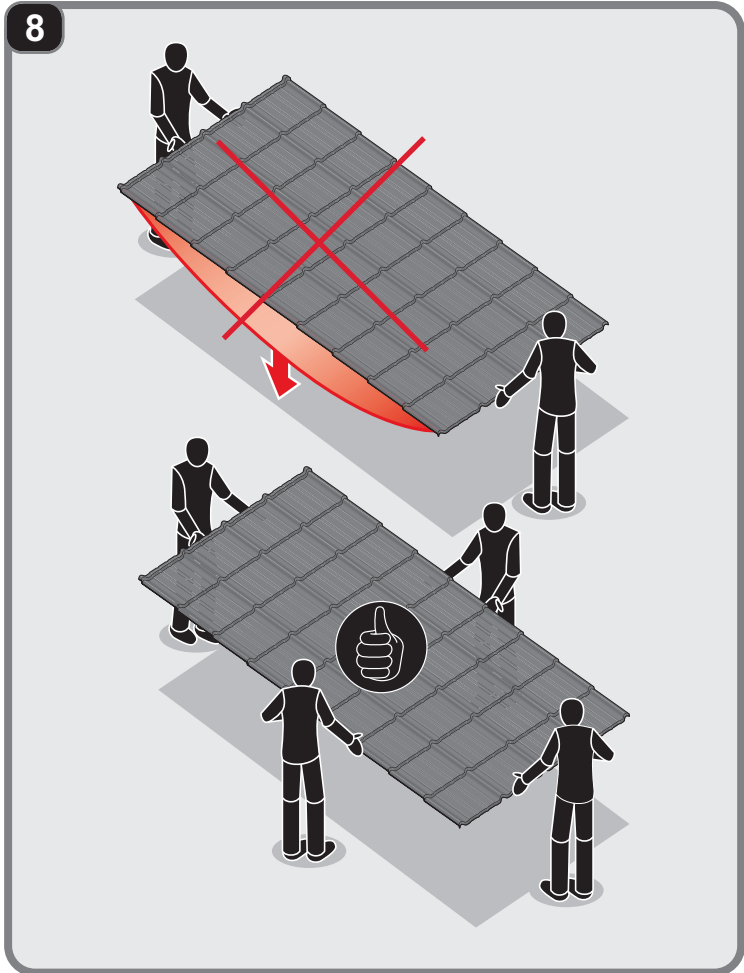
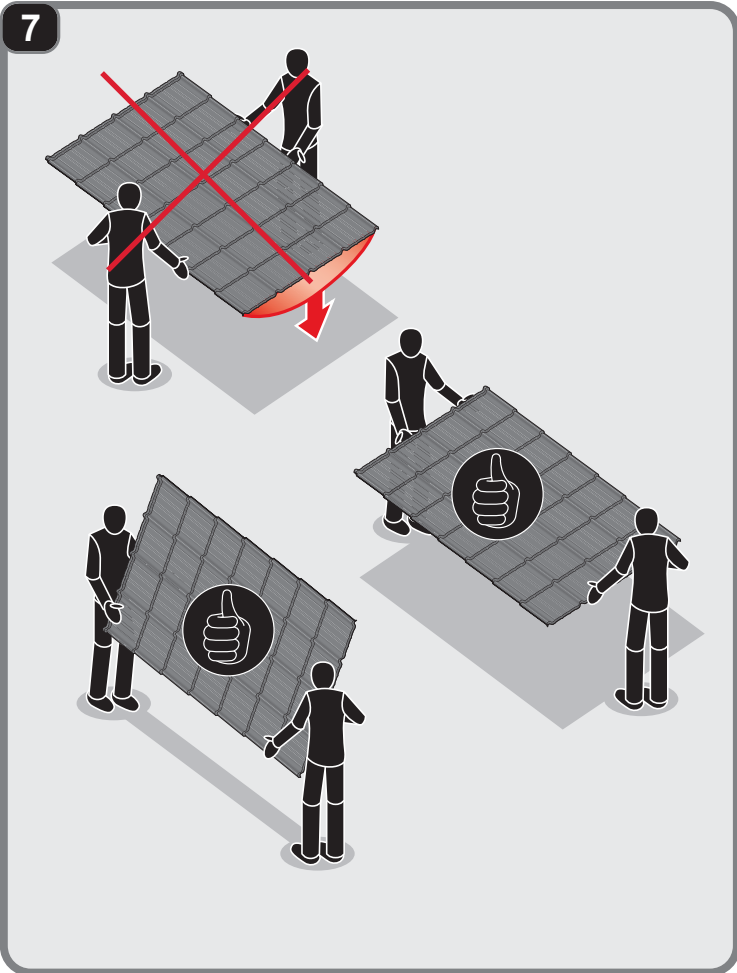
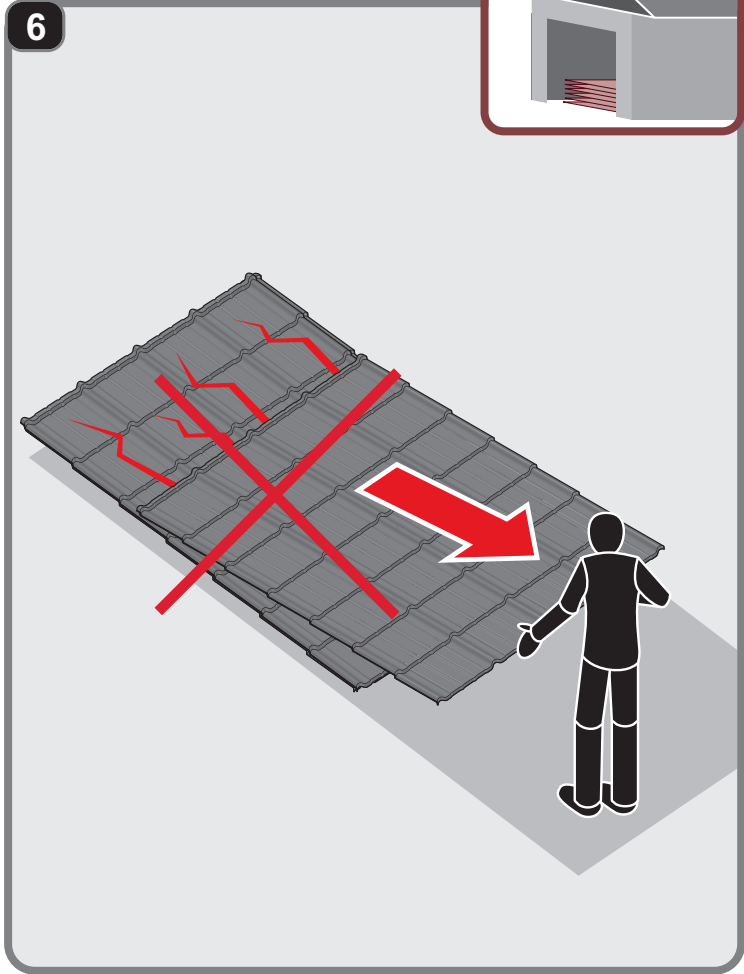
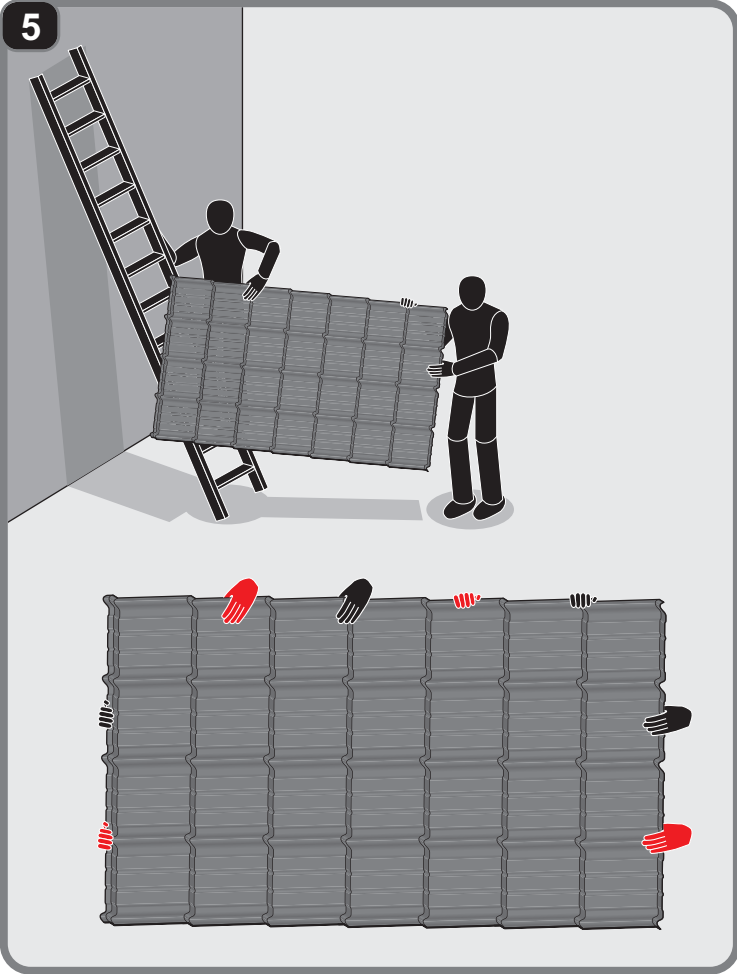
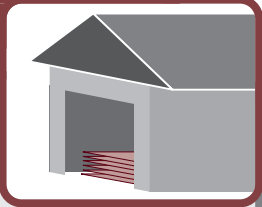



S

0420

Montáž střešních plechů vyžaduje odborné znalosti a zkušenosti. Tento návod je ilustrativní a nezbavuje dodavatele povinnosti dodržovat pravidla pokrývačské praxe a norem. Způsoby montáže uvedené v tomto návodu slouží jako obecné pokyny. Požadovaný způsob montáže se může lišit od toho, který je uveden v návodu v závislosti na typu střechy nebo regionálním řešení. Pro obecné pokyny a tipy pro instalaci postupujte podle pokynů projektanta nebo kontaktujte naše oddělení technické podpory. Zkušení dodavatelé mají individuální řešení, která společnost BLACHOTRAPEZ akceptuje.